



UltraBright™
**Accent Dynamic Tunable White
LED Strip Light**

Product Data Sheet



 Please read all instructions carefully before installation.

Description

Our UltraBright™ Accent Dynamic Tunable White Series is the perfect choice for those who seek the full potential of white tunable lighting. Choose from countless color temperatures between a wide range from 2700K to 6200K and enjoy full dimming capabilities to switch ambiances within seconds. With near-perfect color rendering and a very long run length, these sophisticated lights are made to satisfy the desire for beauty and functionality. These refined tunable strips are also perfect for human-centric lighting, which will help realign your circadian rhythm. Transform your most treasured spaces into safe havens by adjusting color temperatures to fit your schedule or to match your mood. Whether you want to revitalize bedrooms, beautify businesses, or get deeper sleep, the Accent Dynamic Series is made to improve every corner of your life.

15-Year
Warranty



Product Features

CCT	2700K-6200K
CRI	High CRI of 95
Voltage	24V DC Input
Brightness	Up to 277 lm/ft (909 lm/m)
Efficacy	Up to 81 lm/W
LEDs/ft	73 LEDs/ft (240 LEDs/m)
Beam Angle	120° Beam Angle
Ambient Temperature	-4°F to 104°F (-20°C to 40°C)
LED Pitch	3/16" (5 mm)
Strip Width	3/8" (10 mm)
Cutting Points	2" (50 mm)
PCB	4 oz copper
Max Run Length in Series	49 ft (15 m)
LED Size	2216
Adhesive Type	3M VHB 4930 Tape (IP20)
Dimmable	Yes

Product Specifications

Product SKU	Color CCT*	Watts / Foot (Meter)	Lumens / Foot (Meter)	Luminous Efficacy (Lumens/Watt)	CRI	Gamut Score (Rg)	Relative Fidelity Score (Rf)	TLCI
UB-AT1-DYN276295C	All channels on	3.5 W/ft (11.5 W/m)	277 lm/ft (909 lm/m)	81 lm/W	95	105	95	98
	2700K	1.7 W/ft (5.7 W/m)	134 lm/ft (439 lm/m)	79 lm/W	98	102	96	98
	6200K	1.7 W/ft (5.7 W/m)	145 lm/ft (475 lm/m)	85 lm/W	96	104	95	99

*CCT may be +/-100K but always ordered from same bin and will present no noticeable differences perceived by the human eye.

Ordering Code



Dimensions

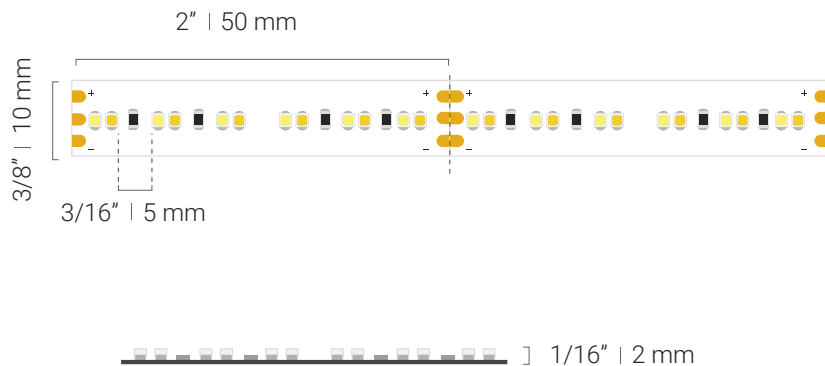

Dimming Options

PWM Dimming

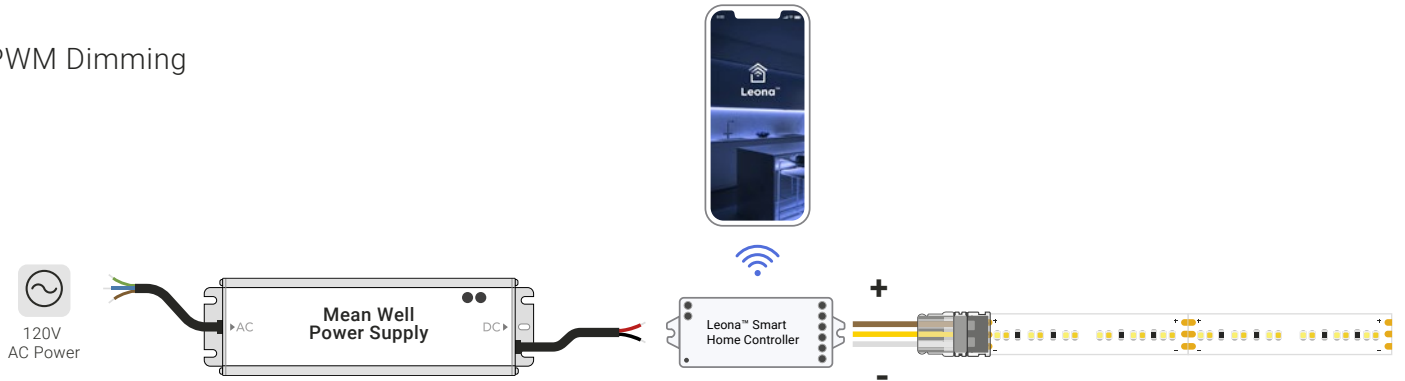

DMX

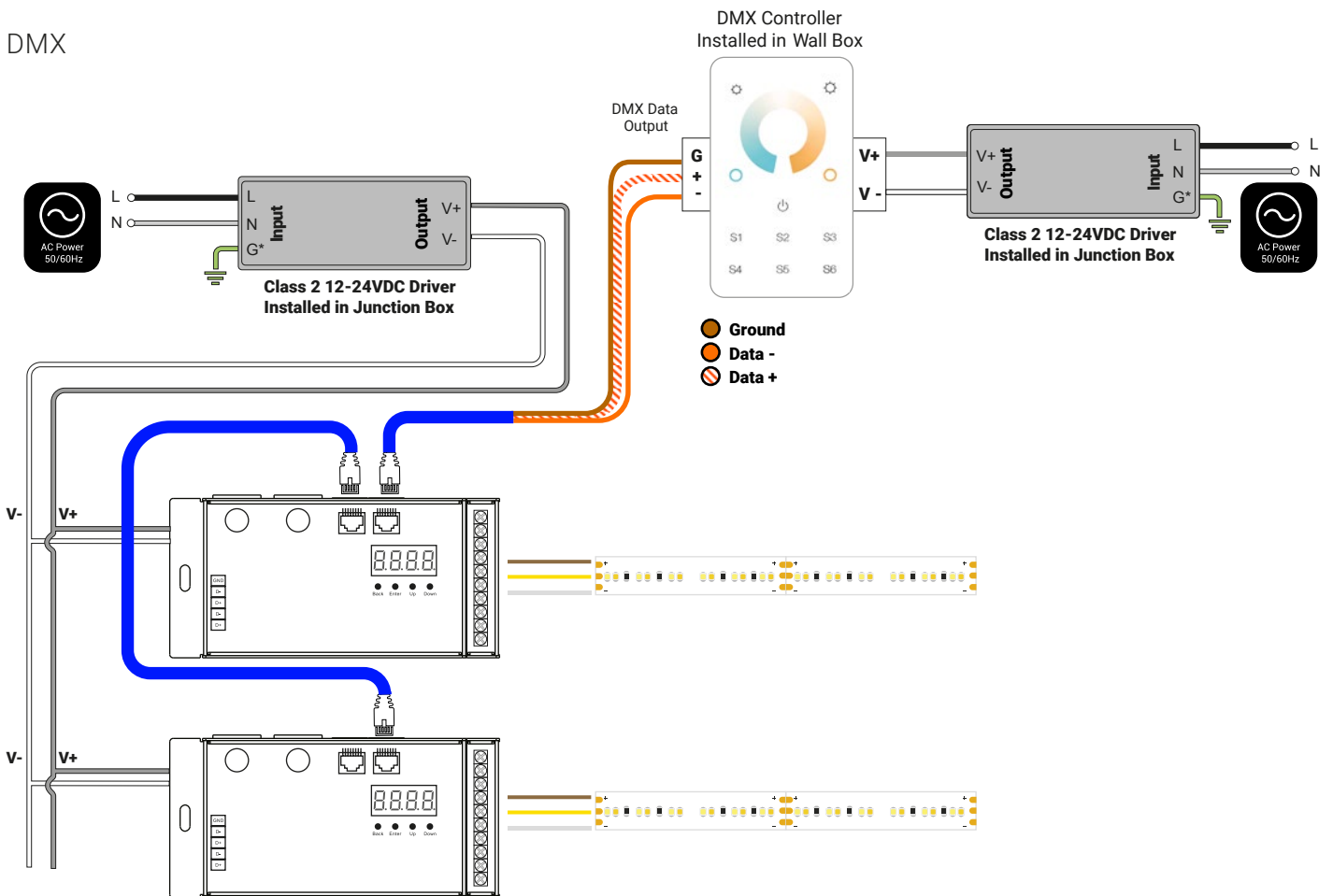

Compatible Drivers (24V)

	Power Supply	LED Strip Length	Product SKU	Watts	Class 2	Diagram
Non-dimmable	Plug-In Power Supply	1 - 5 ft	24V-WMPS2-1	24 W	X	
		6 - 13 ft	24V-DPS2-2.5	60 W	X	
		14 - 21 ft	24V-DPS2-4	96 W	X	
		22 - 27 ft	24V-DPS2-5	120 W		
	Mean Well™ HLG	1 - 15 ft	HLG-60H-24A	60 W	X	
		16 - 24 ft	HLG-100H-24A	96 W	X	
		25 - 47 ft	HLG-185H-24A	185 W		
		48 - 82 ft	HLG-320H-24A	320 W		
		83 - 154 ft	HLG-600H-24A	600 W		
	Mean Well™ LPV	1 - 14 ft	LPV-60-24	60 W	X	



Strip Light Connectors

SKU	Description	Wire Gauge	Amperage** Limit	Diagram
GRIP-SC-C1-10-0*	Attaches LED strip directly to a Power Supply/Driver, low voltage control or DC source.	20 AWG	5 Amps	
GRIP-SC-C1-10-12* GRIP-SC-C1-10-36*	Attaches LED strip directly to a Power Supply/Driver, low voltage control or DC source.	20 AWG		
GRIP-SC-C2-10-06*	Attaches two sections of LED strip together. Wire lead allows for turns around tight corners.	20 AWG		
GRIP-SC-C3-10-0*	Attaches two sections of LED strip together in a continuous run.	-		

*Calculate max length of LED strip to follow the solderless connector based on an amperage draw of 0.15 A/ft (0.48 A/m) at 24 volts.

**Be sure no more than 5 amps is drawn after any solderless connector.

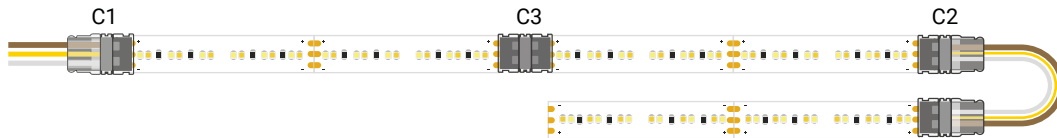

Solderless Connection Guide

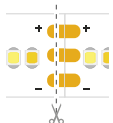

When installing connectors with certain LED Tape Lights such as our Dynamic Tunable White, or Sienna Dim-to-Warm, you will need additional copper pad to work with. You need to cut both solder pads so that the piece to be attached to the connector has more surface area to insert into the connector head.

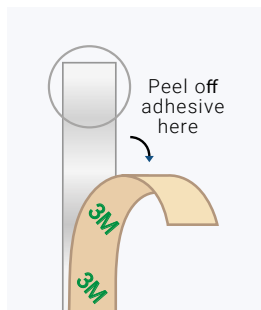

1. Remove 1/4" of 3M adhesive tape on the back from the end of the strip that you want to connect. It must be removed to allow it to fit properly with the solderless connector.

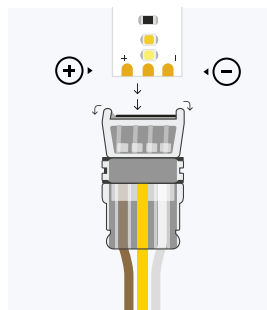

2. Double check the polarity of the strip to match the positive (+) markings together and negative (-) markings together. If you accidentally close the connector before you're ready, you can use a small flathead screwdriver to pry the top back open.

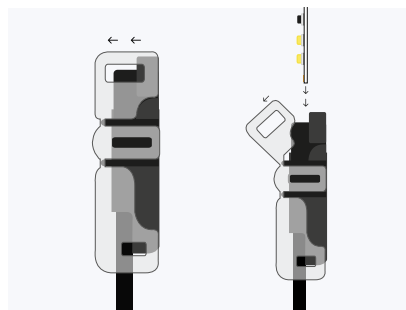

3. Open the top of the grip connector and insert the LED strip inside. Make sure the LED strip is facing up towards the translucent top and the solder pads are directly above the small hooks on the connector.

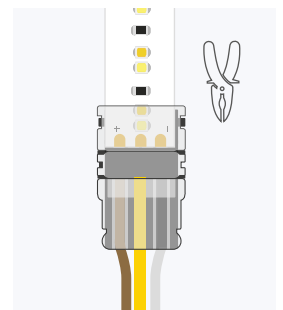







4. Once everything is in order, use pliers to close and lock the connector. You'll hear a "click" sound when it is properly closed.

NOTE: Soldering is the preferred method. If you need further assistance, please download our Solderless Connector Installation Guide from our website.

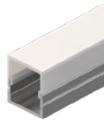
Compatible Aluminum Extrusions

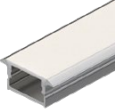
Flexfire LEDs Mounting Channel Kits

Name	Type	Included Accessories	Covers	Kit SKU	Mockup
Ion™	Surface Mount	-	-	ION-CH-A-1M	
Atlas™	Angled Mount	2 Open End Caps 2 Closed End Caps 4 Metal Mounting Clips	Clear Cover Frosted Cover Matte Cover	ATL-CH-A-CVR-C-1M ATL-CH-A-CVR-F-1M ATL-CH-A-CVR-M-1M	
Gemini™	Surface Mount	2 Open End Caps 2 Closed End Caps 4 Metal Mounting Clips	Clear Cover Frosted Cover Matte Cover	GEM-CH-A-CVR-C-1M GEM-CH-A-CVR-F-1M GEM-CH-A-CVR-M-1M	
Kepler™	Surface Mount	2 Open End Caps 2 Closed End Caps 4 Metal Mounting Clips	Clear Cover Frosted Cover Matte Cover	KEP-CH-A-CVR-C-1M KEP-CH-A-CVR-F-1M KEP-CH-A-CVR-M-1M	
		Note: This extrusion only fits the UltraBright™ Accent Dynamic White LED strip without connectors.			
Laika™	Surface Mount	2 Open End Caps 2 Closed End Caps 4 Metal Mounting Clips	Clear Cover Frosted Cover Matte Cover	LAI-CH-A-CVR-C-1M LAI-CH-A-CVR-F-1M	
		Note: This extrusion only fits the UltraBright™ Accent Dynamic White LED strip without connectors.			
Nova™	Surface Mount	2 Open End Caps 2 Closed End Caps 4 Metal Mounting Clips	Clear Round Cover Clear Square Matte Round Cover Matte Square Cover	NOV-CH-A-CVR-C-RD-1M NOV-CH-A-CVR-C-SQ-1M NOV-CH-A-CVR-M-RD-1M NOV-CH-A-CVR-M-SQ-1M	
Titan™	Surface Mount	2 Open End Caps 2 Closed End Caps 4 Metal Mounting Clips	Clear Cover Frosted Cover Matte Cover	TTN-CH-A-CVR-C-1M TTN-CH-A-CVR-F-1M TTN-CH-A-CVR-M-1M	
Calypso™	Recessed Mount	2 Open End Caps 2 Closed End Caps 4 Metal Mounting Clips	Clear Cover Frosted Cover Matte Cover	CAL-CH-A-CVR-F-1M CAL-CH-A-CVR-M-1M	
Cassini™	Recessed Mount	2 Open End Caps 2 Closed End Caps 4 Metal Mounting Clips	Clear Cover Frosted Cover Matte Cover	CAS-CH-A-CVR-C-1M CAS-CH-A-CVR-F-1M CAS-CH-A-CVR-M-1M	
Phoenix™	Recessed Mount	2 Open End Caps 2 Closed End Caps 6 Channel Connectors	Frosted Cover Matte Cover	PHO-CH-A-CVR-F-1M PHO-CH-A-CVR-M-1M	

Safety And Disclosures

1. Installation must be in accordance with local and national electrical code regulations.
2. To ensure safety and correct installation, our strips are intended to be installed by a qualified, licensed electrician.
3. Only install with a Class 2 DC Constant Voltage LED driver to meet UL requirements.
4. Do not install in environment where excessive heat may exist. We encourage the use of a heat sink for heat dissipation purposes when using the UltraBright™ Slim Series LED Strip Light.
5. LED strip lights must be handled with care. Excessive handling, bending, and pressure may damage the product, voiding the warranty.
6. Do not install indoor LED tape light products in outdoor / wet location environments. Only use copper wiring. Use wires rated for at least 176°F (80°C) and certified for use with external connection of electrical equipment.
7. Each maximum run requires a dedicated power feed from the driver. Do not extend beyond the recommended maximum run length.
8. Make sure the appropriate gauge wire is installed between LED driver, LEDs, and any dimmers. When choosing wire, calculate voltage drop, maximum amperage rating, and the location ratings on the wire. Improper wire selection and installation could overheat wires, and cause fire.
9. Do not modify product beyond instructions or warranty will be void.
10. We reserve the right to modify and improve the design of our fixtures without prior notice. Although we try our best to order the same colors every time, due to changes in technology and phosphors over time, we cannot guarantee to match existing installed fixtures for subsequent orders or replacements in regards to product appearance, CCT, or lumen output.

Warranty Information

Limited Warranty

This product has a 15 year limited warranty from the date of shipment. This warranty only includes the main product outlined in this specification sheet and does not include the additional accessories that are used as a reference. Complete warranty details for fixtures and additional accessories are available at <https://www.flexfireleds.com/warranties/> within the Policies section. For warranty related questions please contact the product support team at (support@flexfireleds.com).

Consumer's Acknowledgment

Flexfire LEDs, Inc. stands behind its products when they are used properly and according to our specifications. When you purchase our products, you are agreeing to the terms and conditions outlined in our warranty section. We try our best to make recommendations, but the burden of proper installation, design, and maintenance relies on the purchaser. This limited warranty does not include product failures that are the result of: Not using a voltage regulated power supply to connect the LED product or controls; Connecting LED products to the wrong output voltage; Improper connection of power supplies, LED products, or controls; Connecting LED products or controls directly to any AC power source if they are stated for DC only input; Connecting power supplies backwards to an AC power source; Products used in an inappropriate location or in environmental conditions (temperature, humidity, moisture, etc.) outside the normal specified range; Water damage to products not specifically sold as waterproof products; Electrical power surges and spikes; Damage from hail, flooding, tornado, fire, wind, earthquake, lightning, electrical storm, or any other natural disasters or "force majeure" incidences; Damage caused by a vehicle or other accident; Damage caused when transporting the item; Damage to any products that were modified by the user, used for purposes other than as intended or directed, or connected to LED systems or components not purchased from Flexfire LEDs; Products that have been subjected to misuse, mishandling, misapplication or accident. Products used in connection with any components, devices or systems other than those explicitly approved as compatible with Company's products and listed on Company's website. Excessive wear and tear and/or physical or accidental abuse, loss, or theft. Improper repairs or warranty services performed by someone other than Flexfire LEDs will void this warranty.

Contact Information



Toll Free Number:
1-844-353-9347



Local Number:
(925) 273-9080



info@flexfireleds.com



FLEXFIRELEDs

www.flexfireleds.com