



ColorBright™
RGB 600
LED Strip Light

Product Data Sheet



Description

ColorBright™ RGB 600 LED Strip Lights are ideal for projects that require the brightest, most colorful lighting, while also needing dynamic, versatile lights. Our ColorBright™ RGB 600 emits up to 238 lumens per foot of rich and vibrant colors thanks to its thick, 3oz PCB, which also contributes to better heat dissipation and improved lifespan. Thanks to its 4040 LED chips and a tight LED pitch, our ColorBright™ RGB 600 LED Strip will create a robust line of light guaranteed to take your breath away.

Pair this strip with an RGB controller and these strips can change to nearly any color combination you could imagine, offering a wide range of creative options.

7 Year
Warranty



Product Features

Voltage	24V DC Input
LEDs/ft	36 LEDs/ft (120/meter)
Beam Angle	120° Beam Angle
Ambient Temp	-4°F to +113°F (-20°C to 45°C)
Strip Width	3/8" (10 mm)
LED Pitch	5/16" (8 mm)
Cutting Points	2" (50 mm)
Max Run Length in Series	26 ft (8 m)
PCB	3 oz copper
LED Size	4040
Adhesive Type	3M VHB 4930 tape (IP20)
Dimmable	Yes
Spool Size	16.4 ft (5 m)

Product Specifications

Product SKU	Watts/Foot (Meters)	Lumens/Foot (Meters)	Color Wavelength	Segment Lengths	Max Run Length in Series
CB-RGB600-24V	6.1 W/ft (20 W/m)	231 lm/ft (759 lm/m)	R: 617-627 nm G: 520-530 nm B: 464-474 nm	2" (50 mm)	26 ft (8 m)

Ordering Code

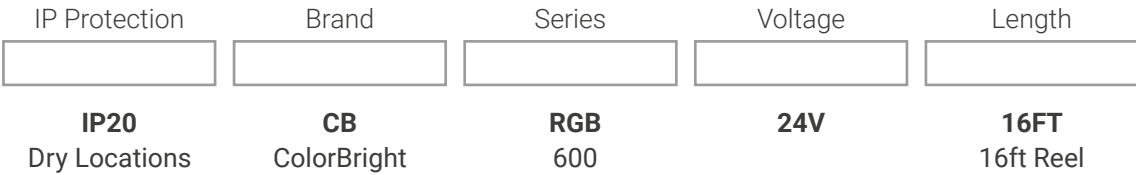

Dimensions

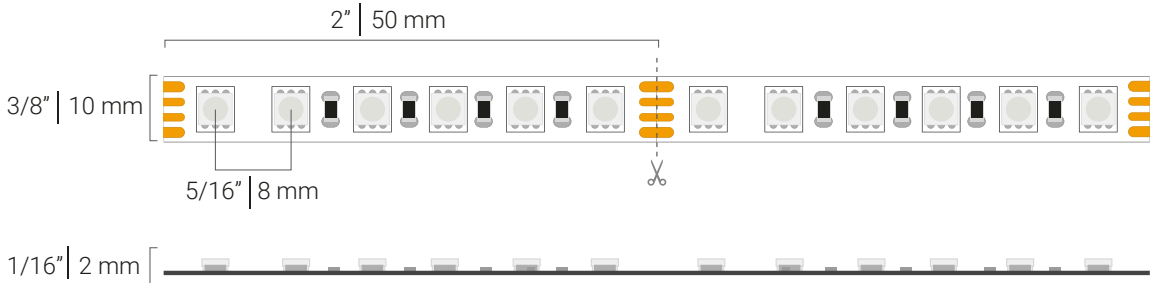

Dimming Options

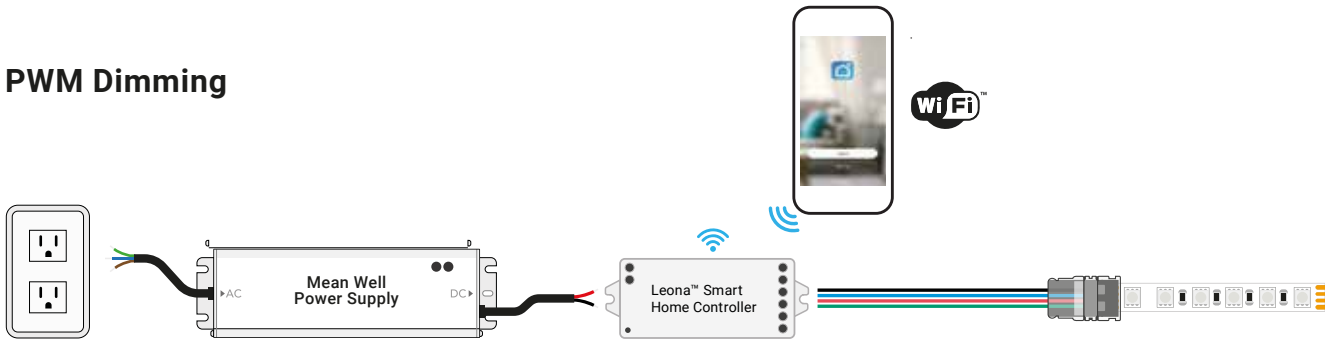

DMX

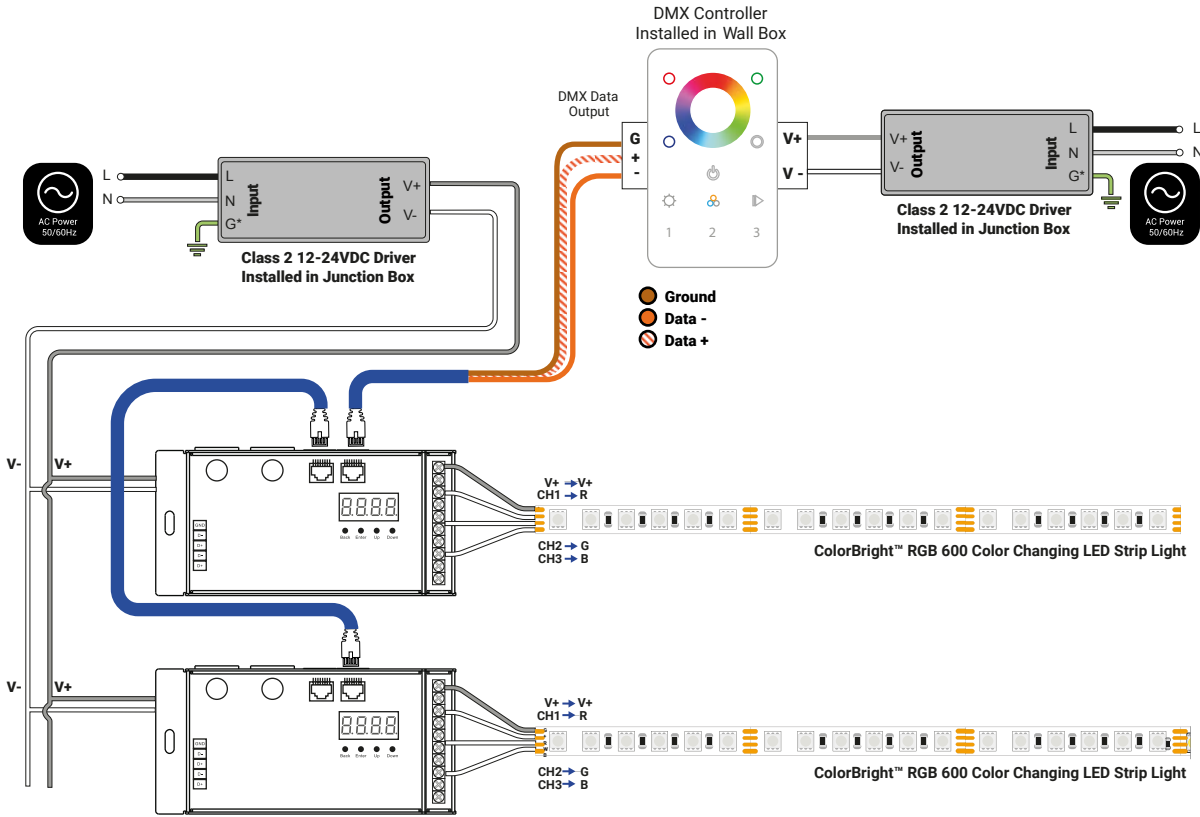

Installation

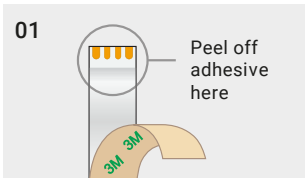

Remove ¼" of 3M adhesive tape on the back from the end of the strip. It must be removed to allow the strip to fit properly within the solderless connector.

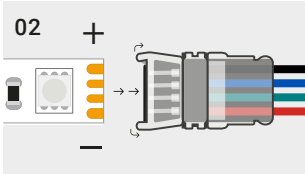

Make sure to use the same color wire for the same channels on the strip. Double check that you are using the same color for the positive (+) channel.

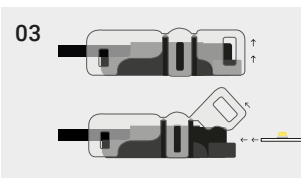

Open the top of the connector and insert the LED strip inside. Make sure the LED strip is facing up towards the translucent top and the solder pads are directly above the small hooks on the connector.

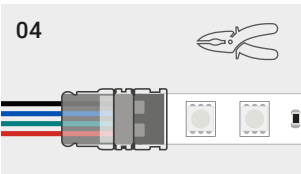

Once everything is in order, use pliers to close and lock the connector. You may hear a "click" sound when it's properly closed.





NOTE: If you need further assistance, please download our Solderless Connector Installation guide.

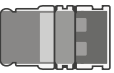

Compatible Drivers

Power Supply	LED Strip Length	Watts	Product SKU	Diagram
Plug-In Power Supply	1 - 3 ft	24 W	24V-WMPS-1	
	4 - 7 ft	60 W	24V-DPS-2.5	
	8 - 12 ft	96 W	24V-DPS-4	
	13 - 15 ft	120 W	24V-DPS-5	
Mean Well™ HLG	1 - 5 ft	40 W	HLG-40H-24A	
	6 - 8 ft	60 W	HLG-60H-24A	
	9 - 14 ft	96 W	HLG-100H-24A	
	15 - 17 ft	120 W	HLG-120H-24A	
	18 - 27 ft	185 W	HLG-185H-24A	
	28 - 35 ft	240 W	HLG-240H-24A	
	36 - 47 ft	320 W	HLG-320H-24A	
	48 - 88 ft	600 W	HLG-600H-24A	
Mean Well™ LPV	1 - 2 ft	20 W	LPV-20-24	
	3 - 5 ft	36 W	LPV-35-24	
	6 - 8 ft	60 W	LPV-60-24	

Strip Light Connectors

SKU	Description	Wire Gauge	Amperage** Limit	Diagram
GRIP-RGB-C1-10-0	Grip connector for RGB Strip Light	-	5 Amps	
GRIP-RGB-C1-10-12	Grip connector with 12" wire connector for RGB Strip Light	20 AWG		
GRIP-RGB-C1-10-36	Grip connector with 36" wire connector for RGB Strip Light	20 AWG		
GRIP-RGB-C2-10-06	Grip Jumper connector with 6" wire for for RGB Strip Light	20 AWG		
GRIP-RGB-C3-10-0	Grip Jumper connector for RGB Strip Light	-		

* Calculate max length of LED strip to follow the solderless connector based on an amperage draw of 0.25 A/ft (0.83 A/m) at 24 volts.
 ** Be sure no more than 5 amps is drawn after any solderless connector.

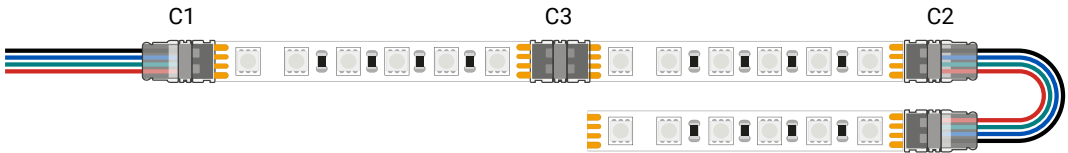

Compatible Aluminum Extrusions

Name	Type	Included Accessories	Covers	Kit SKU	Mockup
Gemini™	Surface Mount	2 Open End Caps	Clear Cover, 1 m (3' 3/8")	GEM-CH-A-CVR-C-1M	
		2 Closed End Caps	Frosted Cover, 1 m (3' 3/8")	GEM-CH-A-CVR-F-1M	
		4 Metal Mounting Clips	Matte Cover, 1 m (3' 3/8")	GEM-CH-A-CVR-M-1M	
Nova™	Surface Mount	2 Open End Caps	Clear Round Cover, 1 m (3' 3/8")	NOV-CH-A-CVR-C-RD-1M	
		2 Closed End Caps	Clear Square, 1 m (3' 3/8")	NOV-CH-A-CVR-C-SQ-1M	
		4 Metal Mounting Clips	Matte Round Cover, 1 m (3' 3/8")	NOV-CH-A-CVR-M-RD-1M	
			Matte Square Cover, 1 m (3' 3/8")	NOV-CH-A-CVR-M-SQ-1M	
Atlas™	Surface Mount	2 Open End Caps	Clear Cover, 1 m (3' 3/8")	ATL-CH-A-CVR-C-1M	
		2 Closed End Caps	Frosted Cover, 1 m (3' 3/8")	ATL-CH-A-CVR-F-1M	
		4 Metal Mounting Clips	Matte Cover, 1 m (3' 3/8")	ATL-CH-A-CVR-M-1M	
Titan™	Surface Mount	2 Open End Caps	Clear Cover, 1 m (3' 3/8")	TTN-CH-A-CVR-C-1M	
		2 Closed End Caps	Frosted Cover, 1 m (3' 3/8")	TTN-CH-A-CVR-F-1M	
		4 Metal Mounting Clips	Matte Cover, 1 m (3' 3/8")	TTN-CH-A-CVR-M-1M	
		6 Channel Connectors			
Ion™	Surface Mount	-	-	ION-CH-A-1M	
Laika™	Surface Mount	2 Open End Caps	Clear Cover, 1 m (3' 3/8")	LAI-CH-A-CVR-C-1M	
		2 Closed End Caps	Frosted Cover, 1 m (3' 3/8")	LAI-CH-A-CVR-F-1M	
		4 Metal Mounting Clips			
Note: This extrusion only fits the ColorBright™ RGB 600 LED strip without connectors.					
Kepler™	Surface Mount	2 Open End Caps	Clear Cover, 1 m (3' 3/8")	KEP-CH-A-CVR-C-1M	
		2 Closed End Caps	Frosted Cover, 1 m (3' 3/8")	KEP-CH-A-CVR-F-1M	
		4 Metal Mounting Clips	Matte Cover, 1 m (3' 3/8")	KEP-CH-A-CVR-M-1M	
Note: This extrusion only fits the ColorBright™ RGB 600 LED strip without connectors.					



Safety And Disclosures

1. Installation must be in accordance with local and national electrical code regulations.
2. To ensure safety and correct installation, our strips are intended to be installed by a qualified, licensed electrician.
3. Only install with a Class 2 DC Constant Voltage LED driver to meet UL requirements.
4. For best results we highly recommend using this strip light in conjunction with an aluminum channel or other heat sink. Because this high output strip generates more heat than the average strip we highly recommend NOT using it for recessed applications, even when paired with a channel. Not following this recommendation can lead to a significantly reduced product lifetime.
5. LED strip lights must be handled with care. Excessive handling, bending, and pressure may damage the product, voiding the warranty.
6. Do not install indoor LED tape light products in outdoor / wet location environments. Only use copper wiring. Use wires rated for at least 176°F (80°C) and certified for use with external connection of electrical equipment.
7. Each maximum run requires a dedicated power feed from the driver. Do not extend beyond the recommended maximum run length.
8. Make sure the appropriate gauge wire is installed between the driver, LEDs, and any dimmers. When choosing wire, calculate voltage drop, maximum amperage rating, and the location ratings on the wire. Improper wire selection and installation could overheat wires, and cause fire.
9. Do not modify the product beyond instructions or warranty will be void.
10. We reserve the right to modify and improve the design of our fixtures without prior notice. Although we try our best to order the same colors every time, due to changes in technology and phosphors over time, we cannot guarantee to match existing installed fixtures for subsequent orders or replacements in regards to product appearance, CCT, or lumen output.

Warranty Information

Limited Warranty

This product has a 7 year limited warranty from the date of shipment. This warranty only includes the main product outlined in this specification sheet and does not include the additional accessories that are used as a reference. Complete warranty details for fixtures and additional accessories are available at <https://www.flexfireleds.com/warranties/> within the Policies section. For warranty related questions please contact the product support team at (support@flexfireleds.com).

Consumer's Acknowledgment

Flexfire LEDs, Inc. stands behind its products when they are used properly and according to our specifications. When you purchase our products, you are agreeing to the terms and conditions outlined in our warranty section. We try our best to make recommendations, but the burden of proper installation, design, and maintenance relies on the purchaser.

This limited warranty does not include product failures that are the result of: Not using a voltage regulated power supply to connect the LED product or controls; Connecting LED products to the wrong output voltage; Improper connection of power supplies, LED products, or controls; Connecting LED products or controls directly to any AC power source if they are stated for DC only input; Connecting power supplies backwards to an AC power source; Products used in an inappropriate location or in environmental conditions (temperature, humidity, moisture, etc.) outside the normal specified range; Water damage to products not specifically sold as waterproof products; Electrical power surges and spikes; Damage from hail, flooding, tornado, fire, wind, earthquake, lightning, electrical storm, or any other natural disasters or "force majeure" incidences; Damage caused by a vehicle or other accident; Damage caused when transporting the item; Damage to any products that were modified by the user, used for purposes other than as intended or directed, or connected to LED systems or components not purchased from Flexfire LEDs; Products that have been subjected to misuse, mishandling, misapplication or accident. Products used in connection with any components, devices or systems other than those explicitly approved as compatible with Company's products and listed on Company's website. Excessive wear and tear and/or physical or accidental abuse, loss, or theft. Improper repairs or warranty services performed by someone other than Flexfire LEDs will void this warranty.

Contact Information



Toll Free Number:
1-844-353-9347



Local Number:
(925) 273-9080



info@flexfireleds.com



FLEXFIRELEDs

www.flexfireleds.com