



FLEXFIRELEDS

PRODUCT CATALOG



We Are Here to Help!

We're an inspired and insatiably curious group of lighting nerds from various industries and walks of life who simply love giving great service. Since 2010, we have specialized in manufacturing and perfecting our lighting products that are used to illuminate beautiful interior and exterior spaces.

We offer some of the highest quality lights on the planet. We don't just sell light strips though We sell the full-functional potential of lighting done right. We understand the primordial connection between humanity and lighting. We believe that great lighting is biologically necessary for humans and emotionally satisfying. Beautiful lighting affects emotion. We will help you create your project's desired emotion: whether it is comfort, security, inspiration, love, excitement, focus, calm, etc.

Did I mention we love customer service? We promise to educate, not sell. We welcome every client's project as if it was our own. We believe in doing things right, from the most basic of components soldered into our products, to ensuring a smile on your face when your project is complete and finally 'comes to light'.

Thank you for your trust in Flexfire LEDs. We won't let you down.

Brent Mauriello, CEO

Flexfire LEDs

Welcome to Flexfire LEDs

Our goal is to offer you the best LED products in the world with the best customer experience! We are NOT just any brand LED products. We take pride in our first-class customer service and in our flawless product design and quality. From Netflix headquarters, to movie sets; from 5-star hotel rooms to the international space station; from your office to your very own home - our strips have been installed just about everywhere you could imagine.



Verified Quality and Durability

Flexfire products are consistently built to last. Our LEDs are tested to be among the brightest available and assembled reliably with quality top components. We set the highest standard for color consistency, longevity, and years of durable life.



Industry-Leading Educational Resources and Personnel

You no longer have to be confused by the complexity of LED technology. We're dedicated to spreading the word about the impact, utility and flexibility of LED lighting. In addition to holding ourselves to high standards, we participate in several industry organizations which set and maintain standards of safety and quality.



End-To-End Dedication to Customers and Their Projects

Whether you are a contractor or homeowner, architect or electrician: let us be your consultants. We have extensive experience and rally around the success of every project. Tell us about your LED lighting project and we'll tell you the most effective way to execute it.

Index

Intro to LED Strip Lighting:	What Are LED Strip Lights?	06
	Inspire: What Can LED Strips Do?	08
	Create: How to Design LED Strip Light Projects	09
	A Little About Light	11
	LED IP Ratings	13
Static White LED Strip Lights:	Outline™ Series	18
	Accent™ Series	20
	Slim™ Series	22
	Architectural™ Series	24
	Render™ Series	26
	Industrial™ Series	28
	Static White Comparison Chart	32
Tunable White LED Strip Lights:	Accent™ Dynamic Tunable White Series	39
	Architectural™ Dynamic Tunable White Series	41
	Sienna™ Dim-to-Warm Series	43
	Dynamic Tunable White Comparison Chart	45
RGB Color Changing LED Strip Lights:	RGB 150 Series	52
	RGB 300 Series	54
	RGB 600 Series	56
	RGBW Series	58
	RGB + Tunable White Series	60
	RGB Digital Pixel™ Series	62
	RGB Color Changing Comparison Chart	64
Single Color Output LED Strip Lights:	Vivid Color Series	71
	ColorBright™ Ultraviolet Series	73
	Single Color Comparison Chart	75
Specialty Outdoor Lighting:	Lucid™ Flexible LED Neon Strip Lights	76
	Valor™ IP67 Premier Diffusion Series	82
LED Light Fixtures:	ClickBright™ Linkable LED Light Bars	85
	Endeavor™ 120V Cove Fixtures	88
	Victory™ Puck Lights	91
Accessories:	Mounting Channels	95
	Power Supplies	97
	Controllers, Dimmers, Connectors & Wire	99
Glossary:	LED Lighting Glossary	100





INTRODUCTION TO
LED Strip Lights

What Are LED Strip Lights?

An LED strip light is a flexible circuit board that is populated with LEDs. It has a strong adhesive backing and can easily be stuck to most surfaces. The strip can be utilized almost anywhere in order to add powerful lighting in a variety of colors and brightnesses.



Cut to Length

Our strips can be cut every few inches, meaning you can easily customize the strip to fit your space.



Flexible

You aren't limited to lighting flat spaces. LED strips are flexible and can be bent vertically up to soft 90 degrees.



Low Profile

Most strips have a thickness of 1/16" (2 mm) so they may be installed in tight spaces and can easily be hidden from view.

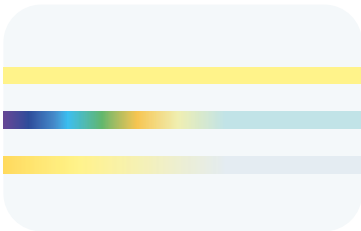

Color Options

Select from a variety of single colors and color changing options.

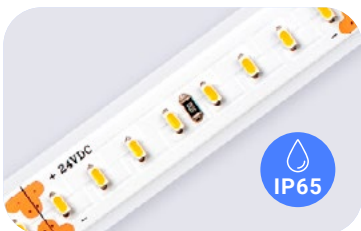

Added Protection

IP65 protection can be added to make the strips weather and water resistant.



Fully Dimmable

Our LEDs are dimmable and compatible with a variety of home automation systems, wall, and remote dimmers. You have complete control over your LEDs.



Peel & Stick

The back of the strip is fitted with a strong 3M brand adhesive tape, allowing you to peel and stick lights to many different surfaces.



Customizable

We are able to customize specialty strips for volume requirements to include custom colors, lengths, CRI, width, voltage, brightness, and more. Contact us to learn more.



Highest Safety Standards

Our LED strip lights are UL, CE, and RoHS listed. They do not contain any hazardous substances and pose no safety risks.

Our Warranties

We work our hardest to use only the highest quality components in our products. We recognize that most people do not use their lighting systems 24 hours a day, and strive to match our LED's longevity data with a warranty that fits the majority of our customers' use cases.



**Free project
advice**



**Up to 15-year
warranty**



**30-day money
back guarantee**



**Personalized
service & support**

Inspire: What Can LED Strips Do?

Our LED strip lights and accessories provide beautiful lighting solutions for a wide range of projects and applications. Each project you have may require special needs in terms of LED strip brightness, length, dimming constraints, and power usage.

Residential Applications



Coves



Above Cabinet



Under Cabinet



Under Counter



Toe Kicks



Stairways



Outdoor Accents



Bathroom Accents

Commercial Applications



Restaurant and Bars



Signage Lighting



Display / Merchandise



Hotel and Resort

Specialty Applications

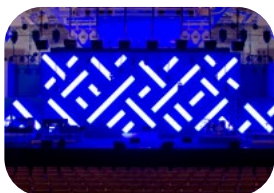

Events and Stages



Terrarium Lighting

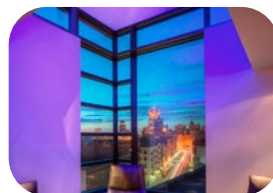

Ultraviolet (UV)



Art Displays

Create: How to Select Your Lighting System

LED strip lights are not “one size fits all” lighting solutions. Our strip lights are highly adaptable and customizable to fit the precise needs of your project. Follow the steps below to easily design your lighting system.

1 Choose Output Style

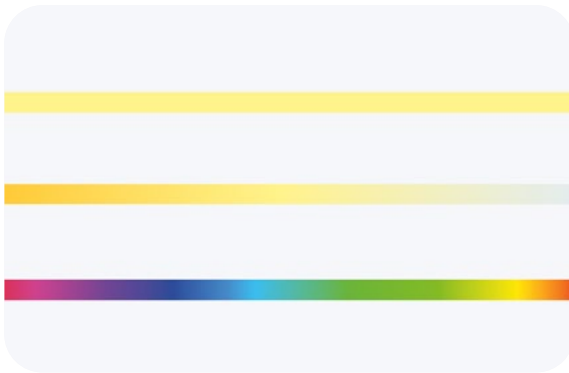

Choose from Monochromatic (Single Color), Dynamic Tunable White, or RGB Color Changing outputs. Which style best suits your project?

2 Choose Desired Brightness



Choose the level of brightness for your project. Our lights are fully dimmable and come in a variety of brightness levels.

3 Color Options

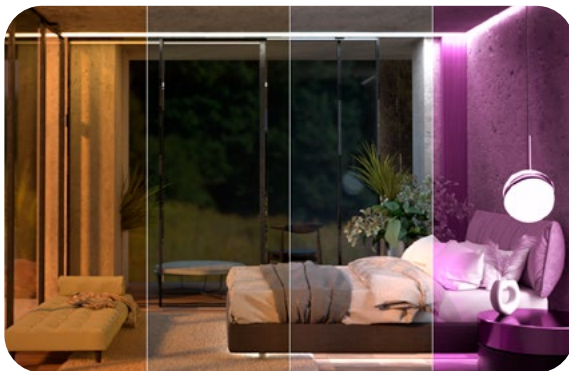

Choose which color(s) or shade of white you would like for your project.

4 Dimming & Control Options



Complete control of your space. On and off aren't your only options. LED strips are fully dimmable and can be controlled remotely.

5 Powering Your Lights



After you have chosen your output type, length, and dimmer, you can choose your power supply. Not sure? We're here to help you with this.

6 Added Protection



Will these be exposed to the elements? If so, choose IP65 rating or above to protect your lights from water, dust and debris.

7 Mounting Extrusions



Choose an optional aluminum channel to house your strip lights. Dramatically increase design possibilities using extrusions.

8 Connecting Your Lights



While soldering is the best option for connecting strip lights, we have a variety of connectors available to connect different strips to one another or to connect strips to power supplies.









A Little About Light

Correlated Color Temperature (CCT)



Not all white light appears the same. Correlated Color Temperature (CCT) defines the color appearance of a white light. CCT is defined in degrees Kelvin. Most white lights fall in a spectrum between 1800K and 6500K. When falling below 3000K, the light looks noticeably warmer like a candle. On the other end of the spectrum, the lights have a bluish tint and cooler tone when passing above 6500K. Some color temperatures will better suit your design than others. Choose complementary highlighting tones and look at example photos to find what you think will look best.

Lumen (Brightness)

Brightness	 450 lumens	 800 lumens	 1100 lumens	 1600 lumens	 2600 lumens	 5800 lumens
Bulb						
LED	6W	9-10W	13W	16-18W	24W	45W
CFL	8-9W	13-14W	18-19W	23W	40W	85W
Regular (Incandescent)	40W	60W	75W	100W	150W	300W
Halogen	29W	43W	53W	72W	150W	300W

A lumen is a measurement of lighting that represents the visible light output of a light source. We are all accustomed to using watts to measure the brightness of light, because of incandescent lighting. Today, we use lumens. Lumens are the most important variable when choosing your strip light. The higher the number, the brighter the light will be. Ensure that the strips you choose are bright enough for your application's intention.

CRI - Color Rendering Index



The Color Rendering Index (CRI), also known by some as color accuracy, is a term of measurement of how natural the light given off by a source looks in comparison to the sun. Have you ever purchased a red towel or dress in the store and when you try it on at home or wear it outside in the sun it looks different? This is because the CRI is different between the two light sources.



High CRI LEDs will show an object's true and vibrant color. The highest CRI is 100. Great CRI is measured above 80 while excellent CRI measures over 90. Our High CRI strips have a minimum 94 CRI and have been measured up to 98.

LED IP Ratings

IP is an acronym for Ingress Protection. It is a measurement of the protection an item will have against solid objects (dust, sand, dirt, etc.) and liquids. An IP rating is comprised of 2 numbers that give you information about the protection level. A higher number means greater protection. The first number (0-6) refers to the level of protection against solid objects and moving parts, such as dust, debris, or other solid matter. The second number (0-8) references the level of liquid and moisture protection.

Take a look at the chart below to better understand the protection offered with each number.

1st digit - SOLID Degree of protection against solid objects			2nd digit - LIQUID Degree of protection against water		
0	No Protection		0	No Protection	
1	Protected against a solid object greater than 50 mm, such as a hand.		1	Protected against water drops.	
2	Protected against a solid object greater than 12,5 mm, such as a finger.		2	Protected against water drops at a 15 degree angle.	
3	Protected against a solid object greater than 2,5 mm, such as a wire.		3	Protected against water sprays at a 60 degree angle.	
4	Protected against a solid object greater than 1 mm, such as a thin strap.		4	Protected against water splashing from any angle.	
5	Dust protected. Prevents ingress of dust sufficient to cause harm.		5	Protected against water jets from any angle.	
6	Dust tight. No ingress of dust.		6	Protected against powerful water jets and heavy seas.	
<div style="display: flex; justify-content: space-around; align-items: center;"> <div style="text-align: center;"></div> <div style="text-align: center;"></div> <div style="text-align: center;"></div> </div> <p>Most of our strips are available in IP20 or IP65 ratings, please take this into consideration when selecting the strip that best suits your project. Our Valor Series has an IP67 rating.</p>			7	Protected against the effects of temporary submersion in water. (30 minutes at 3 feet)	
			8	Protected against the effects of permanent submersion in water. (Up to 13 feet)	

Example: With an IP65 rating, the LEDs can be used in an outside setting and are water-resistant but they are not waterproof and are not suitable to be submerged. On the other hand, an IP67 rated strip could resist short accidental submersions.

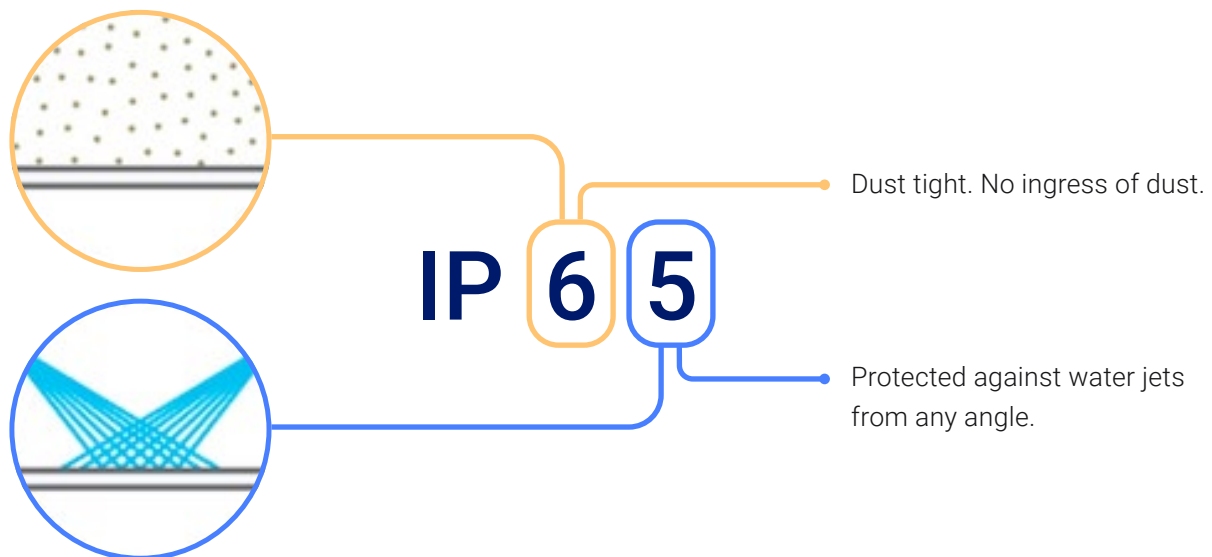

The differences between commonly sold IP65, IP67, & IP68 strips are slight, but very important. Using our chart as a guide, we can see that all these strips are protected at the highest level from solids and dust. The variations come with the protection against liquids.

IP65 = Water resistant. Protected against water jets from any angle. Do not submerge IP65 LED lights, these are not waterproof.

IP67 = Water resistant plus. Protected against the events of temporary submersion (10 minutes). Do not submerge IP67 LED lights for extended periods, these are not fully waterproof.

What IP Rating Will You Need?

If you don't anticipate a harsh environment that is extremely dusty or wet then a lower IP rating would suffice. In places that will have a lot of dust, debris, or potential to be in contact with any solids or liquids, you'll want to make sure that the IP ratings are high and that you have adequate water resistant or waterproof coatings on your LED strip lights.

Low IP ratings are appropriate for indoor use, protected use inside sealed products, inside sealed signage, when using aluminum extrusions. High IP ratings are appropriate for unsealed outdoor locations, places that have a lot of debris, areas with heavy foot traffic, high splash areas, high contact areas (people touching them) and wet locations.

Static White

LED STRIP LIGHTS

From subtle to bright output with near-perfect CRI. Find the perfect white LED strip for any commercial or residential application.





Outline™ Series

The Outline™ Series is specifically designed to create long runs of elegant, energy-efficient lighting. Perfect for accent and ambient lighting with near-perfect color rendering.



Lumen Output:

Up to 132 lm/ft (434 lm/m)



Power:

1.5 W/ft (4.8 W/m)



Color Temperatures:

27K, 30K, 35K, 40K, 50K



Accent™ Series

The Accent™ Series is a perfect blend of innovative design with practical functionality that guarantees sophisticated lighting made for beautiful accent and ambient lighting. One of our favorite strips!



Lumen Output:

Up to 300 lm/ft (985 lm/m)



Power:

3.5 W/ft (11.5 W/m)



Color Temperatures:

27K, 30K, 35K, 40K, 50K



Slim™ Series

Some spaces are too narrow to accommodate standard width strip lights. The Slim™ Series is ultra-thin (1/8" - 4 mm wide) allowing you to add blazingly bright light to even more spaces.



Lumen Output:

Up to 391 lm/ft (1,255 lm/m)



Power:

4.6 W/ft (15.1 W/m)



Color Temperatures:

30K, 50K



Architectural™ Series

The Architectural™ Series is boldly built with the market's leading components to create an incredibly bright strip with excellent color rendering and long run lengths. Meets the high standards of architectural design and complex lighting projects.



Lumen Output:

Up to 502 lm/ft (1,646 lm/m)



Power:

4.4 W/ft (14.4 W/m)



Color Temperatures:

27K, 30K, 35K, 40K, 50K

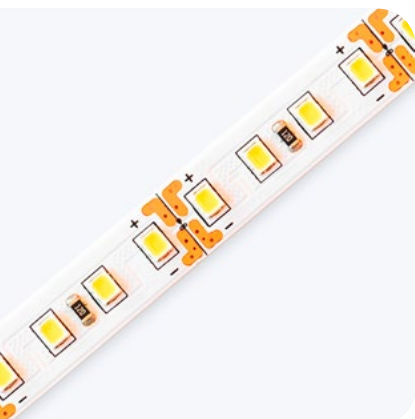

Render™ Series

The Render™ Series is designed with a very high output up to 870 lm/ft and spectacularly high CRI, TLCI, R9, and R13 values. Perfect for professional-grade studio lighting and high-level accent lighting for film, photography, fashion, art, and more.



Lumen Output:

Up to 870 lm/ft (2,852 lm/m)



Power:

6.6 W/ft (21.6 W/m)



Color Temperatures:

30K, 35K, 40K, 50K

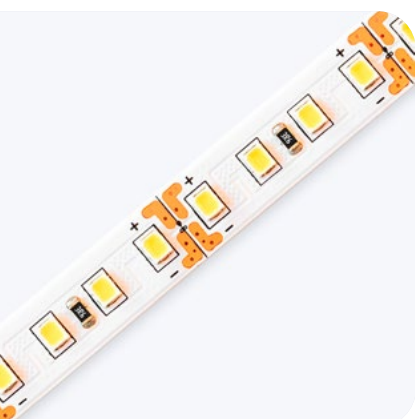

Industrial™ Series

The Industrial™ Series is one of the brightest strips on the market, emitting up to a staggering 1,156 lm/ft while sustaining a high color rendering index. Best suited for industrial and architectural design applications, along with custom OEM solutions.



Lumen Output:

Up to 1,156 lm/ft (3,793 lm/m)



Power:

6.6 W/ft (21.6 W/m)



Color Temperatures:

30K, 35K, 40K, 50K, 62K

Outline™ Series



15-year
warranty



[> Visit Product Page](#)

Description

Less is more with our UltraBright™ Outline Series. We carefully designed these lights for a specific need for a lower-output strip that will guarantee an elegant, subtle glow with remarkable color accuracy for an unforgettable first impression. Longer run lengths also give you liberated, uninterrupted design as you get creative with larger projects. From embellishing charming coves to outlining industrial spaces, the Outline™ Series is both versatile and specific.



Lumen Output:

Up to 132 lm/ft (434 lm/m)



Power:

1.5 W/ft (4.8 W/m)



Color Temperatures:

27K, 30K, 35K, 40K, 50K



Available IP Versions

Product Features

- High CRI up to 97
- High R9 (99) & R13 (97) values
- Up to 132 lm/ft (434 lm/m)
- Fully dimmable
- Highest quality components and premium packaged 2216 LEDs
- Single bin LED selection to ensure color consistency (3-Step MacAdam)
- Thermally resistant 3M VHB adhesive for long lasting bond
- 120° beam angle
- Efficacy up to 86 lm/W
- Width: 3/8" (10 mm) in IP20, 1/2" (12 mm) in IP65
- Short LED pitch of 5/16" (8 mm)
- 24V DC input voltage
- Can be cut every 2" (51 mm)
- Ambient temperature: -4°F to 113°F (-20°C to 45°C)
- Thick double layer 4 oz copper PCB for excellent thermal management
- 37 LEDs/ft (120 LEDs/m)
- Maximum run length in series: 82 ft (25 m)
- Can be used to comply with Title 24 for CCTs below 4000K

Dimensions

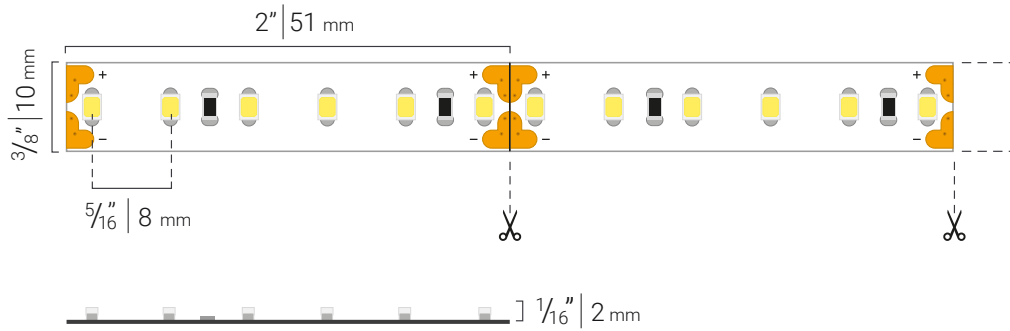

Specifications

Product SKU	Color (CCT)	Watts / Foot (Meter)	Lumen / Foot (Meter)	Luminous Efficacy (Lumens / Watt)	CRI	Gamut Score Rg (Color Sat.)	Relative Fidelity Score (RF)	TLCI (Qa)	CQS
UB-OL-27K97C	2700K	1.5 W/ft 4.8 W/m	123 lm/ft (402 lm/m)	78 lm/W	97	105	95	95	96
UB-OL-30K97C	3000K	1.5 W/ft 4.8 W/m	122 lm/ft (399 lm/m)	83 lm/W	97	103	96	98	97
UB-OL-35K97C	3500K	1.5 W/ft 4.8 W/m	129 lm/ft (423 lm/m)	83 lm/W	97	103	96	98	98
UB-OL-40K95C	4000K	1.5 W/ft 4.8 W/m	130 lm/ft (427 lm/m)	85 lm/W	97	103	96	98	98
UB-OL-50K95C	5000K	1.5 W/ft 4.8 W/m	132 lm/ft (434 lm/m)	86 lm/W	96	103	96	99	98



Accent™ Series



15-year
warranty



[> Visit Product Page](#)

Description

Our Accent™ Series is the perfect choice for homeowners and contractors wanting to uplift and revitalize any room - big or small. Combining beautiful design with practical functionality, these sophisticated lights boast an exceptionally high CRI up to 97, very short LED pitch, and have the shortest cut lines of our products. Whether you want to brighten corners, beautify ceilings, or fabricate depth and dimension, the Accent™ Series is made to truly reinvent your space.



Lumen Output:

Up to 300 lm/ft (985 lm/m)



Power:

3.5 W/ft (11.5 W/m)



Color Temperatures:

27K, 30K, 35K, 40K, 50K



Available IP Versions

Product Features

- High CRI of 97
- High R9 (99) & R13 (98) values
- Up to 300 lm/ft (985 lm/m)
- Fully dimmable
- Highest quality components and premium packaged 2216 LEDs
- Single bin LED selection to ensure color consistency (3-Step MacAdam)
- Thermally resistant 3M VHB adhesive for long lasting bond
- 120° beam angle
- Efficacy up to 80 lm/W
- Width: 3/8" (10 mm) in IP20, 1/2" (12 mm) in IP65
- Short LED pitch of 3/16" (4 mm)
- 12V or 24V DC input voltage
- Can be cut every 1" (25 mm)
- Ambient temperature: -4°F to 113° (-20°C to 45°C)
- Thick double layer 4 oz copper PCB for excellent thermal management
- 73 LEDs/ft (240 LEDs/m)
- Maximum run length in series: 32 ft (10 m) in 12V, 49 ft (15 m) in 24V
- Can be used to comply with Title 24 for CCTs below 4000K

Dimensions

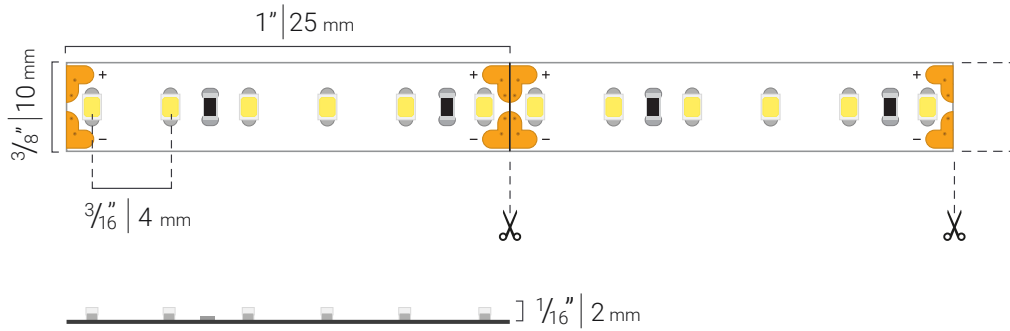

Specifications

Product SKU	Color (CCT)	Watts / Foot (Meter)	Lumen / Foot (Meter)	Luminous Efficacy (Lumens / Watt)	CRI	Gamut Score Rg (Color Sat.)	Relative Fidelity Score (RF)	TLCI (Qa)	CQS
UB-AT1-27K97C	2700K	3.5 W/ft 11.5 W/m	267 lm/ft (877 lm/m)	76 lm/W	97	105	95	95	96
UB-AT1-30K97C	3000K	3.5 W/ft 11.5 W/m	275 lm/ft (901 lm/m)	78 lm/W	97	103	96	98	98
UB-AT1-35K97C	3500K	3.5 W/ft 11.5 W/m	281 lm/ft (921 lm/m)	80 lm/W	97	103	96	98	98
UB-AT1-40K95C	4000K	3.5 W/ft 11.5 W/m	263 lm/ft (864 lm/m)	75 lm/W	97	102	96	98	98
UB-AT1-50K95C	5000K	3.5 W/ft 11.5 W/m	300 lm/ft (985 lm/m)	80 lm/W	97	103	96	99	98

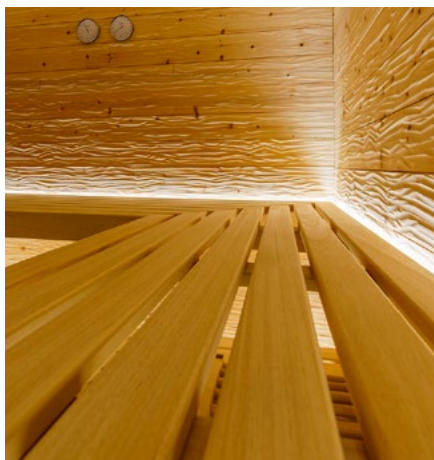

Slim™ Series



7-year
warranty



[> Visit Product Page](#)

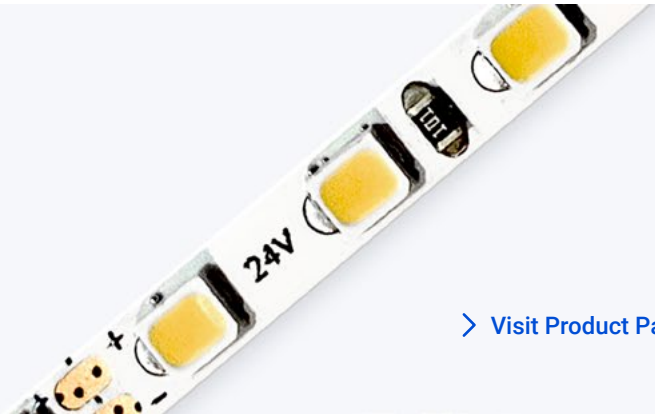

Description

The UltraBright™ Slim Series is an ultra-thin LED strip light with just a bit over a 1/8" (4mm) width, outfitted with very bright LED chips and a strong adhesive backing. The thin design of the strip has been constructed for high brightness, optimal heat dissipation, consistency of color, and great color rendering. It is one of the most narrow LED strip lights on the market. This strip provides elegant, discreet lighting. It is commonly used by architects and lighting designers in professional installations, as well as by OEMs and fabricators within their products. **Heat sink recommended.**



Lumen Output:

Up to 391 lm/ft (1,255 lm/m)



Power:

4.6 W/ft (15.1 W/m)



Color Temperatures:

30K, 50K



Available IP Versions

Product Features

- High CRI up to 95
- Up to 391 lm/ft (1,255 lm/m)
- Fully dimmable
- Highest quality components and premium packaged 2835 LEDs
- Single bin LED selection to ensure color consistency (3-Step MacAdam)
- Thermally Resistant 3M 300 LSE adhesive for long lasting bond
- 120° beam angle
- Efficacy up to 90 Lumens/W
- Ultra slim. Only 1/8" (4 mm) strip width
- Short LED pitch of 1/4" (7 mm)
- 24V DC input voltage
- Can be cut every 2" (50 mm)
- Ambient temperature -4°F to 113°F (-20°C to 45°C)
- Thick double layer 4 oz copper PCB for excellent thermal management
- 36 LEDs/ft (120 LEDs/m)
- Maximum run length in series: 16 ft (5 m)

Dimensions

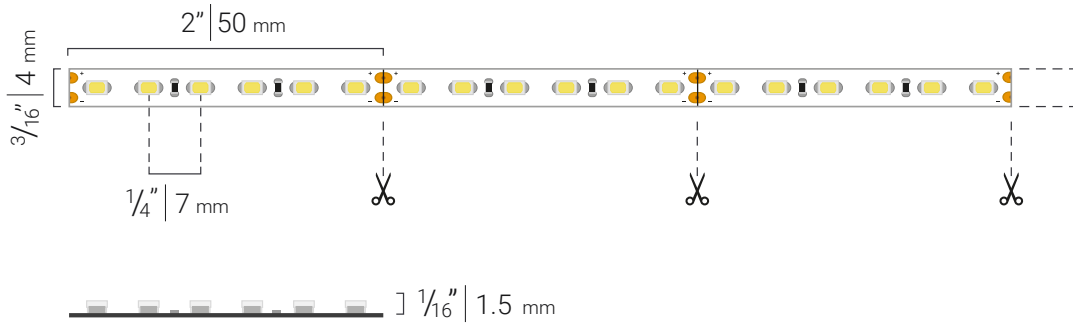

Specifications

Product SKU	Color (CCT)	Watts / Foot (Meter)	Lumen / Foot (Meter)	Luminous Efficacy (Lumens / Watt)	CRI	Gamut Score Rg (Color Sat.)	Relative Fidelity Score (RF)
UB-SS-30K90C	3000K	4.6 W/ft 15.1 W/m	360 lm/ft (1,180 lm/m)	81 lm/W	94	100	92
UB-SS-50K90C	5000K	4.6 W/ft 15.1 W/m	391 lm/ft (1,285 lm/m)	90 lm/W	95	99	91

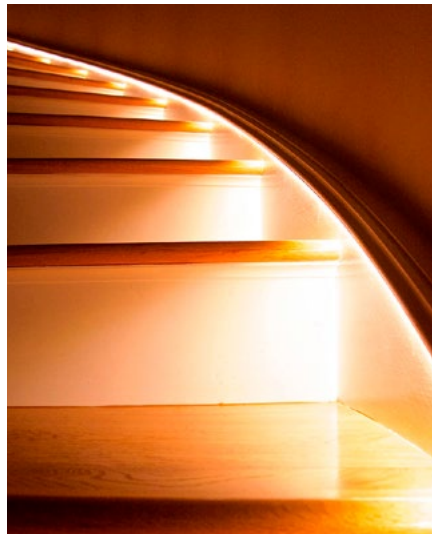

Architectural™ Series



15-year
warranty



[> Visit Product Page](#)

Description

Our Architectural™ Series is built to last and to make lasting impressions. Born to meet the high standard of innovative architectural design and complex lighting projects, the Architectural™ Series is designed with the market's leading components to create an incredibly bright strip with excellent color rendering and long run lengths. Pair this strip with a dimmer to take full advantage of its versatile applications, from bright task lighting to lower, comfortable accents.



Lumen Output:

Up to 502 lm/ft (1,646 lm/m)



Power:

4.4 W/ft (14.4 W/m)



Color Temperatures:

27K, 30K, 35K, 40K, 50K



Available IP Versions

Product Features

- High CRI up to 98
- High R9 (98) & R13 (100) values
- Up to 502 lm/ft (1,646 lm/m)
- Fully dimmable
- Highest quality components and premium packaged 3014 LEDs
- Single bin LED selection to ensure color consistency (3-Step MacAdam)
- Thermally resistant 3M VHB adhesive for long lasting bond
- 120° beam angle
- Efficacy up to 116 lm/W
- Width: 3/8" (10 mm) in IP20, 1/2" (12 mm) in IP65
- Short LED pitch of 1/4" (6.3 mm)
- 12V or 24V DC input voltage
- 12V can be cut every 1" (25 mm)
- 24V can be cut every 2" (51 mm)
- Ambient temperature: -4°F to 113°F (-20°C to 45°C)
- Thick double layer 4 oz copper PCB for excellent thermal management
- 49 LEDs/ft (160 LEDs/m)
- Maximum run length in series: 16 ft (5 m) in 12V, 42 ft (13 m) in 24V
- Can be used to comply with Title 24 for CCTs below 4000K

Dimensions

12V

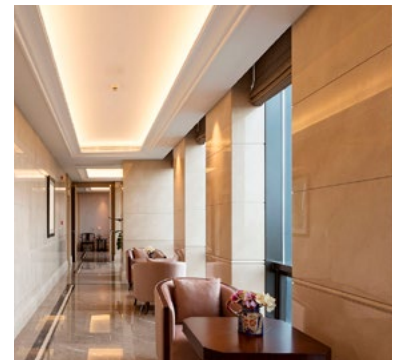
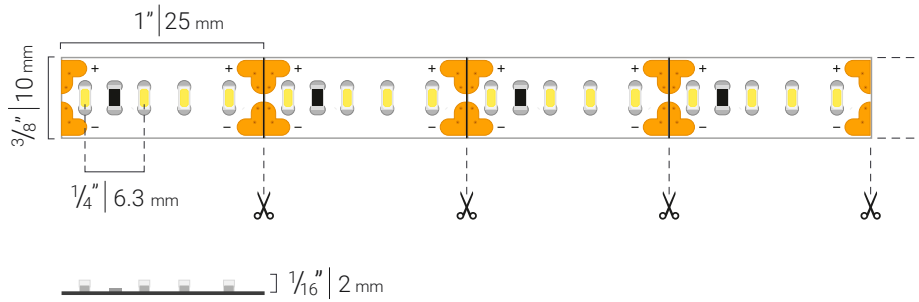

24V

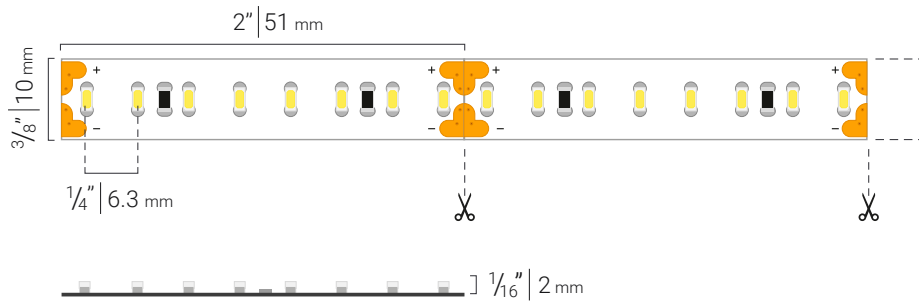

Specifications

Product SKU	Color (CCT)	Watts / Foot (Meter)	Lumen / Foot (Meter)	Luminous Efficacy (Lumens / Watt)	CRI	Gamut Score Rg (Color Sat.)	Relative Fidelity Score (RF)	TLCI (Qa)	CQS
UB-AS-27K90C	2700K	4.4 W/ft 14.4 W/m	466 lm/ft (1,528 lm/m)	104 lm/W	98	101	95	97	96
UB-AS-30K90C	3000K	4.4 W/ft 14.4 W/m	478 lm/ft (1,567 lm/m)	108 lm/W	94	100	92	94	93
UB-AS-35K90C	3500K	4.4 W/ft 14.4 W/m	499 lm/ft (1,636 lm/m)	112 lm/W	95	100	92	95	93
UB-AS-40K90C	4000K	4.4 W/ft 14.4 W/m	493 lm/ft (1,616 lm/m)	114 lm/W	97	99	92	98	95
UB-AS-50K90C	5000K	4.4 W/ft 14.4 W/m	502 lm/ft (1,646 lm/m)	116 lm/W	95	98	91	96	92

Render™ Series



7-year
warranty



[> Visit Product Page](#)

Description

The UltraBright™ Render Series has near-perfect CRI and R9 values to show colors in their true, vibrant forms. With an incredibly high lumen output and full-spectrum lighting, this strip has the remarkable ability to mimic daylight. A short LED pitch guarantees a uniform, bright line of light. From spotlighting favorite pieces of art and photography, to lighting up a movie set or a fashion runway, use this strip to impress a crowd. We use top-quality components and single BIN selection to ensure long-lasting consistency. **Heat sink recommended.**



Lumen Output:

Up to 870 lm/ft (2,852 lm/m)



Power:

6.6 W/ft (21.6 W/m)



Color Temperatures:

30K, 35K, 40K, 50K



Available IP Versions

Product Features

- High CRI up to 98
- High R9 (94) & R13 (96) values
- Up to 870 lm/ft (2,852 lm/m)
- Fully dimmable
- Highest quality components and premium packaged 2835 LEDs
- Single bin LED selection to ensure color consistency (3-Step MacAdam)
- Thermally resistant 3M VHB 4930 adhesive for long lasting bond
- 120° beam angle
- Efficacy up to 129 lm/W
- Only 3/8" (10 mm) strip width
- Short LED pitch of 5/16" (8 mm)
- 24V DC input voltage
- Can be cut every 2 1/2" (64 mm)
- Ambient temperature -4°F to 104°F (-20°C to 40°C)
- Thick double layer 4 oz copper PCB for excellent thermal management
- 36 LEDs/ft (120 LEDs/m)
- Maximum run length in series: 19 ft (6 m)
- Can be used to comply with Title 24 for CCTs below 4000K

Dimensions



Specifications

Product SKU	Color (CCT)	Watts / Foot (Meter)	Lumen / Foot (Meter)	Luminous Efficacy (Lumens / Watt)	CRI	Gamut Score Rg (Color Sat.)	Relative Fidelity Score (RF)	TLCI (Qa)	CQS
UB-RS-30K97C	3000K	6.6 W/ft 21.6 W/m	735 lm/ft (2,411 lm/m)	110 lm/W	97	100	94	99	97
UB-RS-35K97C	3500K	6.6 W/ft 21.6 W/m	833 lm/ft (2,731 lm/m)	125 lm/W	98	100	93	99	96
UB-RS-40K95C	4000K	6.6 W/ft 21.6 W/m	811 lm/ft (2,659 lm/m)	128 lm/W	98	100	93	99	96
UB-RS-50K95C	5000K	6.6 W/ft 21.6 W/m	870 lm/ft (2,852 lm/m)	129 lm/W	98	100	94	99	98



Industrial™ CRI 90+ Series



7-year
warranty



[> Visit Product Page](#)

Description

The UltraBright™ Industrial Series CRI90+ is one of the brightest LED strips on the planet and continues to redefine the limits of LED strip lighting. Boasting an extremely high output up to 972 lm/ft and high CRI up to 96, this strip is made to surpass all expectations and is a popular choice amongst our high-end commercial and OEM clients.

Heat sink recommended.



Lumen Output:

Up to 972 lm/ft (3,187 lm/m)



Power:

6.6 W/ft (21.6 W/m)



Color Temperatures:

30K, 35K, 40K, 50K, 62K



Available IP Versions

Product Features

- High CRI up to 96
- Up to 972 lm/ft (3,187 lm/m)
- Fully dimmable
- Highest quality components and premium packaged 2835 LEDs
- Single bin LED selection to ensure color consistency (3-Step MacAdam)
- Thermally resistant 3M VHB 4930 adhesive for long lasting bond
- 120° beam angle
- Efficacy up to 153 lm/W
- Only 3/8" (10 mm) strip width
- Short LED pitch of 5/16" (8 mm)
- 12V or 24V DC input voltage
- 12V can be cut every 1 1/4" (32 mm)
- 24V can be cut every 2 1/2" (64 mm)
- Ambient temperature -4°F to 104°F (-20°C to 40°C)
- Thick double layer 4 oz copper PCB for excellent thermal management
- 36 LEDs/ft (120 LEDs/m)
- Maximum run length in series:
9 ft (3 m) in 12V, 19 ft (6 m) in 24V
- Can be used to comply with Title 24 for CCTs below 4000K

Dimensions

12V

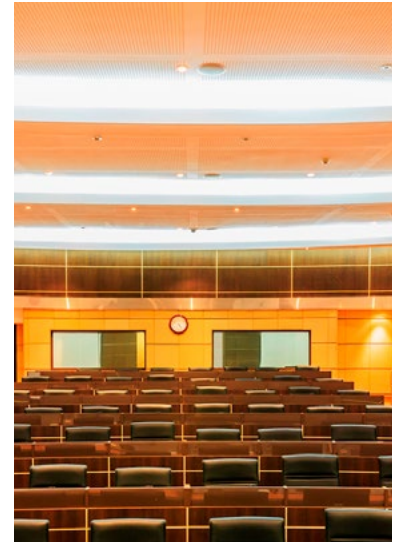
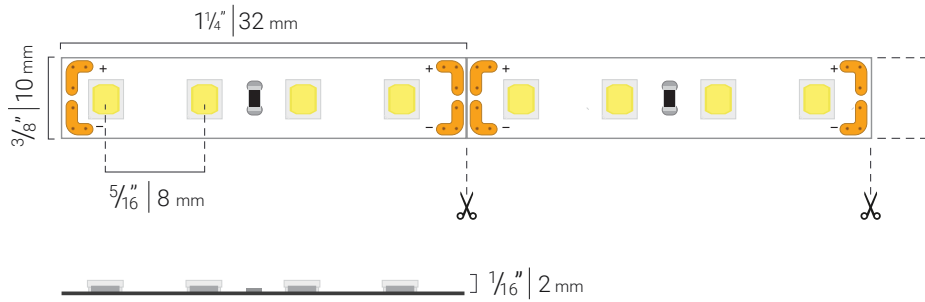

24V

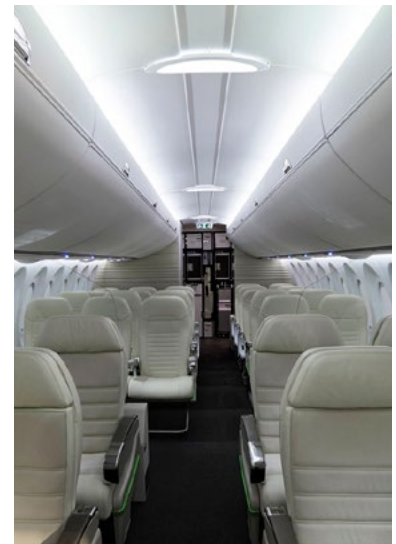
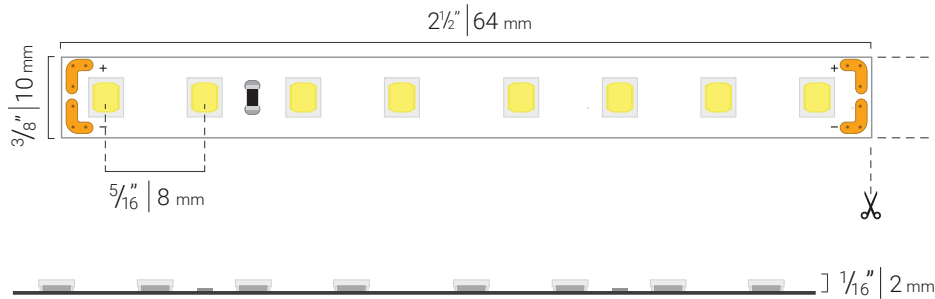

Specifications

Product SKU	Color (CCT)	Watts / Foot (Meter)	Lumen / Foot (Meter)	Luminous Efficacy (Lumens / Watt)	CRI	Gamut Score Rg (Color Sat.)	Relative Fidelity Score (RF)	TLCI (Qa)	CQS
UB-IS-30K90C	3000K	6.6 W/ft 21.6 W/m	939 lm/ft (3,079 lm/m)	146 lm/W	96	101	92	90	95
UB-IS-35K90C	3500K	6.6 W/ft 21.6 W/m	916 lm/ft (3,004 lm/m)	144 lm/W	96	100	91	91	94
UB-IS-40K90C	4000K	6.6 W/ft 21.6 W/m	923 lm/ft (3,029 lm/m)	147 lm/W	94	99	90	89	92
UB-IS-50K90C	5000K	6.6 W/ft 21.6 W/m	972 lm/ft (3,187 lm/m)	153 lm/W	95	100	90	93	92
UB-IS-62K90C	6200K	6.6 W/ft 21.6 W/m	942 lm/ft (3,089 lm/m)	140 lm/W	93	96	88	95	91

Industrial™ CRI 80+ Series



7-year
warranty



[> Visit Product Page](#)

Description

The UltraBright™ Industrial Series CRI80+ is one of the brightest LED strips on the planet. Emitting a staggering 1,156 lm/ft with new 2835 SMD chips, this series continues to redefine and push the limits of LED strip lighting. This strip is made to surpass all expectations of our high-end commercial and OEM clients in lighting, design, and architecture, where excellence is never compromised. **Heat sink recommended.**



Lumen Output:

Up to 1,156 lm/ft (3,793 lm/m)



Power:

6.6 W/ft (21.6 W/m)



Color Temperatures:

30K, 35K, 40K, 50K, 62K



Available IP Versions

Product Features

- High CRI up to 85
- Up to 1,156 lm/ft (3,793 lm/m)
- Fully dimmable
- Highest quality components and premium packaged 2835 LEDs
- Single bin LED selection to ensure color consistency (3-Step MacAdam)
- Thermally resistant 3M VHB 4930 adhesive for long lasting bond
- 120° beam angle
- Efficiency up to 173 lm/W
- Only 3/8" (10 mm) strip width
- Short LED pitch of 5/16" (8 mm)
- 24V DC input voltage
- 24V can be cut every 2 1/2" (64 mm)
- Ambient temperature -4°F to 104°F (-20°C to 40°C)
- Thick double layer 4 oz copper PCB for excellent thermal management
- 36 LEDs/ft (120 LEDs/m)
- Maximum run length in series: 19 ft (6 m)

Dimensions

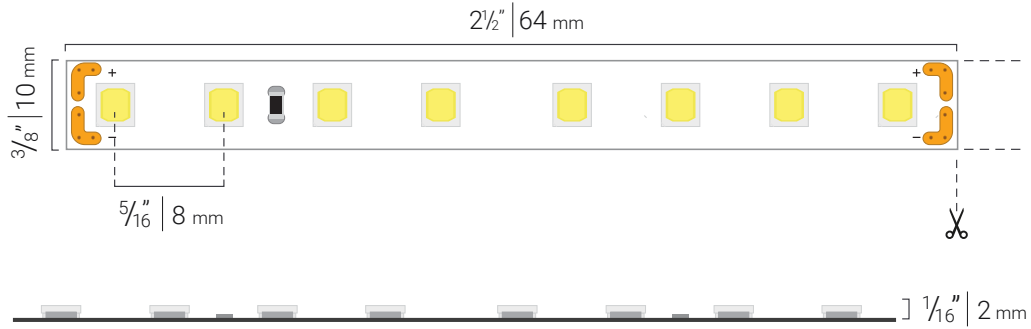





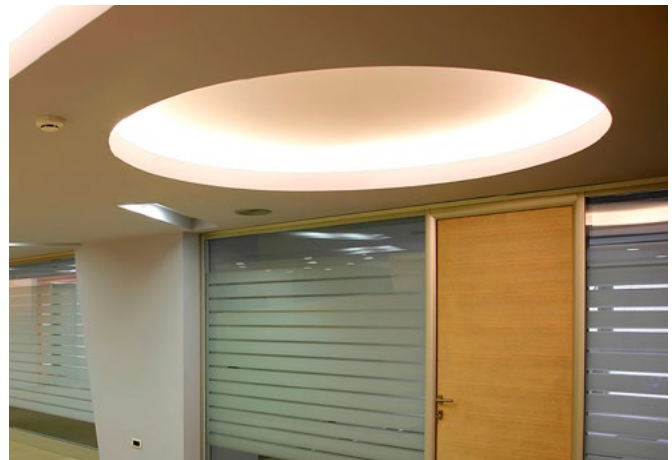

Specifications

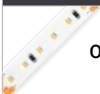
Product SKU	Color (CCT)	Watts / Foot (Meter)	Lumen / Foot (Meter)	Luminous Efficacy (Lumens / Watt)	CRI	Gamut Score Rg (Color Sat.)	Relative Fidelity Score (RF)	TLCI (Qa)	CQS
UB-IS-30K80C	3000K	6.6 W/ft 21.6 W/m	1048 lm/ft (3,439 lm/m)	160 lm/W	85	96	86	72	85
UB-IS-35K80C	3500K	6.6 W/ft 21.6 W/m	1156 lm/ft (3,793 lm/m)	170 lm/W	85	96	85	73	84
UB-IS-40K80C	4000K	6.6 W/ft 21.6 W/m	1126 lm/ft (3,694 lm/m)	168 lm/W	85	94	85	72	84
UB-IS-50K80C	5000K	6.6 W/ft 21.6 W/m	1026 lm/ft (3,366 lm/m)	173 lm/W	85	93	84	73	82
UB-IS-62K80C	6200K	6.6 W/ft 21.6 W/m	1068 lm/ft (3,503 lm/m)	166 lm/W	85	91	83	76	83

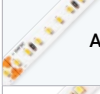

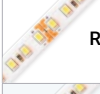
Static White Strips Comparison Chart

LED Strip	Color (CCT)	Brightness	Lumens / ft	Watts / ft	Lumens / Watt	Ingress Protection	CRI	Voltage	Max Run (in series)
 Outline™ Series	27K 30K 35K 40K 50K		~ 132	1.5	~ 86	IP20 IP65	~ 97	24V	82 ft
 Accent™ Series	27K 30K 35K 40K 50K		~ 300	3.5	~ 80	IP20 IP65	~ 97	12V 24V	32 ft 49 ft
 Slim™ Series	30K 50K		~ 391	4.6	~ 90	IP20	~ 95	24V	16 ft
 Architectural™ Series	27K 30K 35K 40K 50K		~ 502	4.4	~ 116	IP20 IP65	~ 98	12V 24V	16 ft 42 ft
 Render™ Series	30K 35K 40K 50K		~ 870	6.6	~ 129	IP20	~ 98	24V	19 ft
 Industrial™ 90+ Series	30K 35K 40K 50K 62K		~ 972	6.6	~ 153	IP20	~ 98	12V 24V	9 ft 19 ft
 Industrial™ 80+ Series	30K 35K 40K 50K 62K		~ 1156	6.6	~ 173	IP20	~ 85	24V	19 ft



Project Gallery

Static White

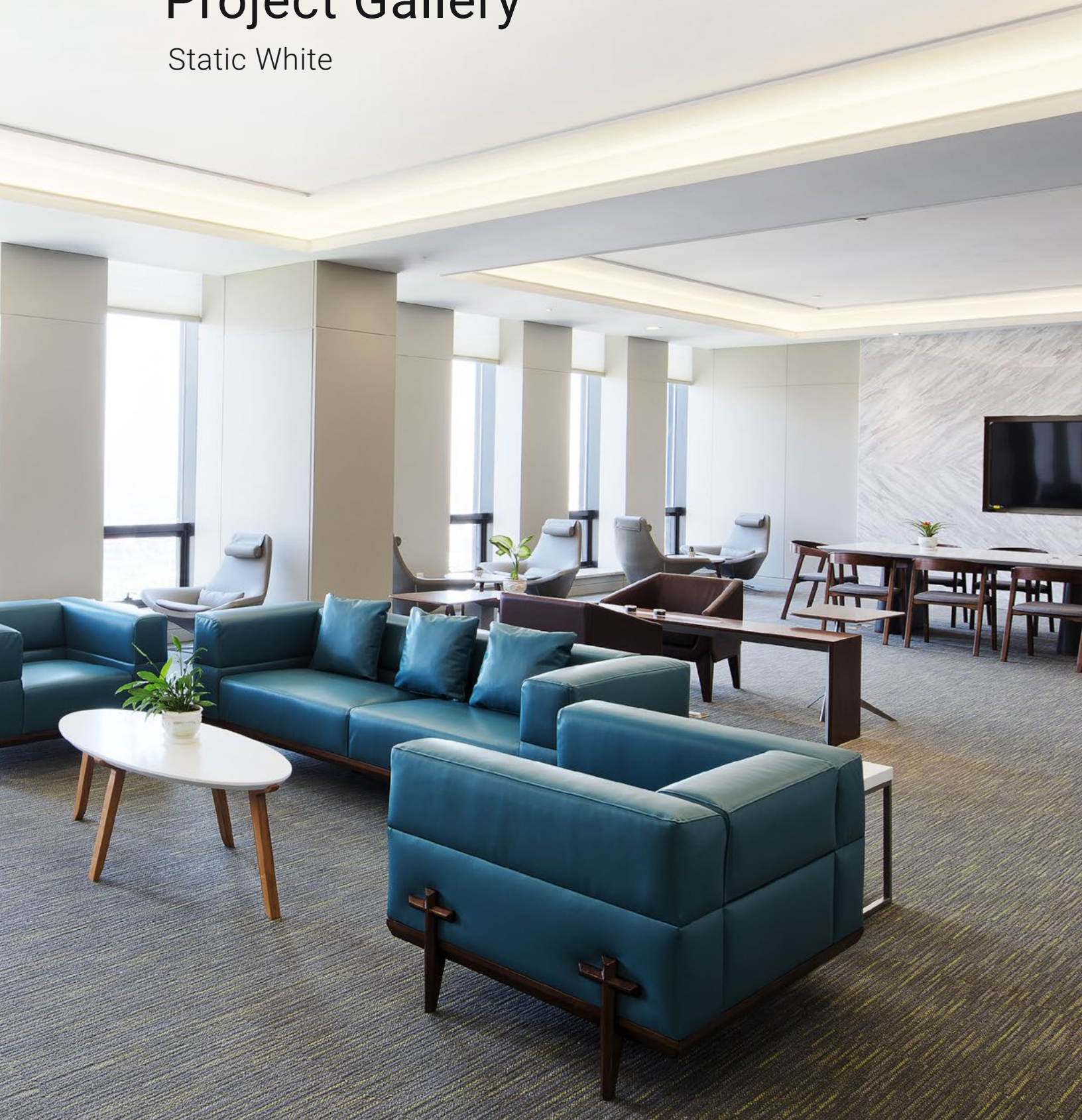





 **Backlighting**
Outline™ Series

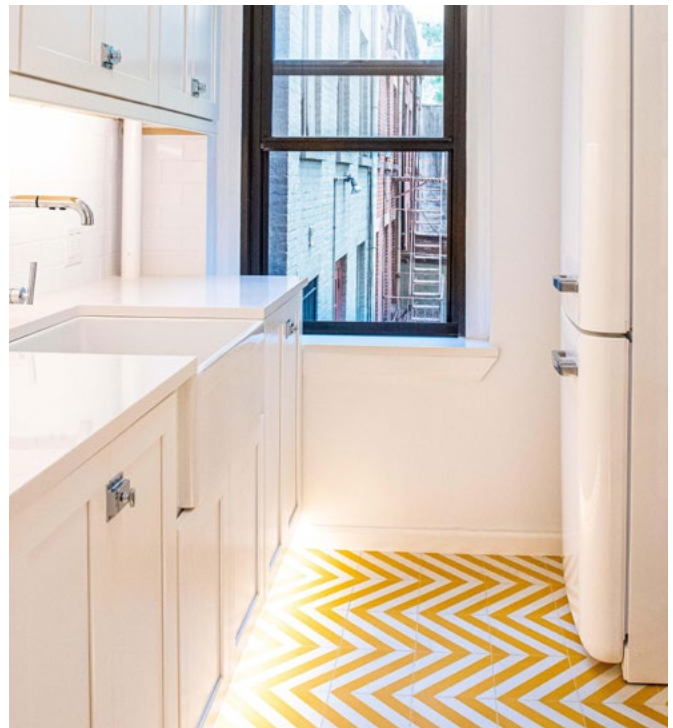

 **Under Cabinet Lighting**
Accent™ Series



 **Toe Kick Lighting**
Accent™ Series



 **Patio / Backyard Lighting**
Outdoor Accent™ Series

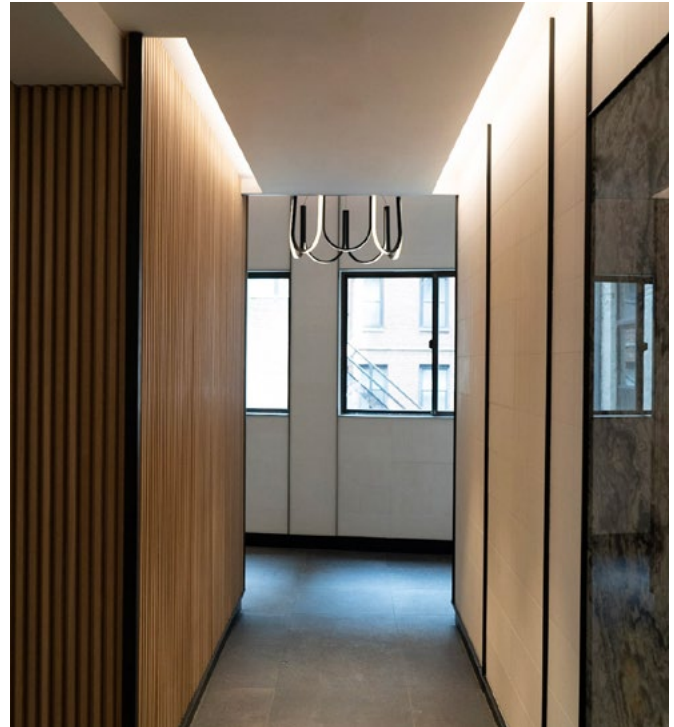

 **Cove / Ceiling Lighting**
Architectural™ Series



 **Bathroom Lighting**
Outdoor Architectural™ Series

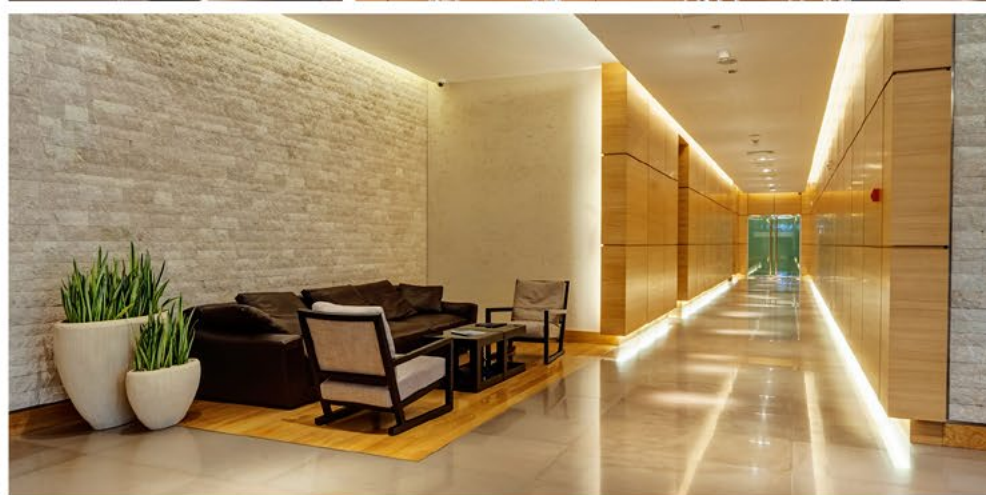
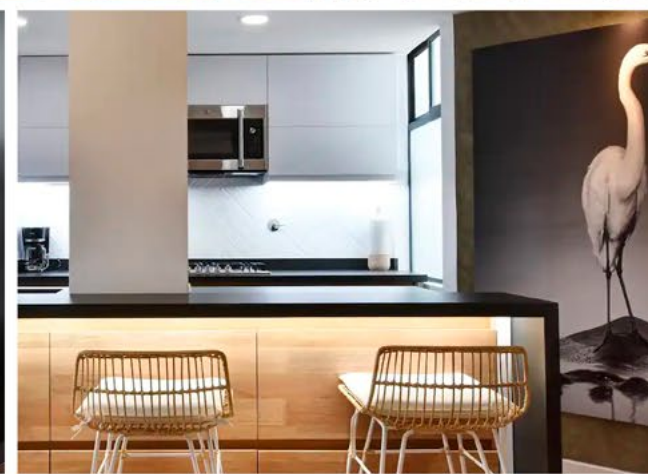
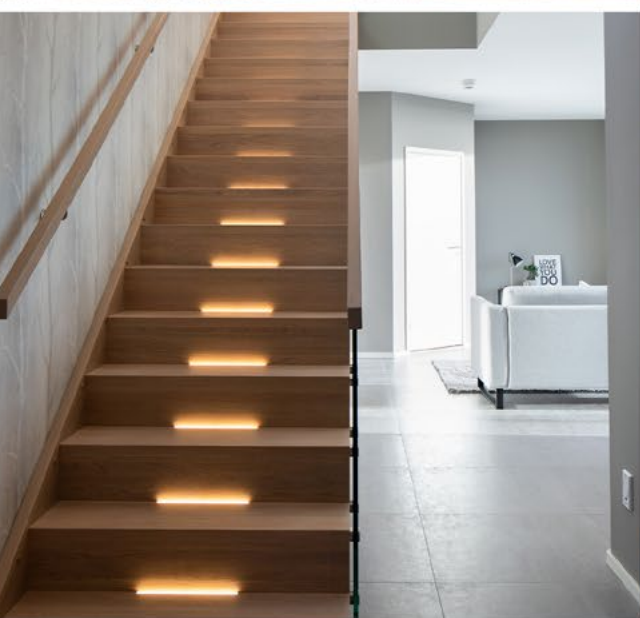

Dynamic Tunable White

LED STRIP LIGHTS

Precise white color temperature at the click of a button. Select your favorite tone and set the perfect mood.





Accent™ Dynamic Tunable White

Our UltraBright™ Accent Dynamic Tunable White Series is the perfect choice for people who are looking for an accent lighting strip that will allow them to find the perfect shade of white. Choose from a wide range of color temperatures between 2700K to 6200K.



Lumen Output:

Up to 266 lm/ft (872 lm/m)



Power:

3.5 W/ft (11.5 W/m)



CCT Range:

2700K - 6200K

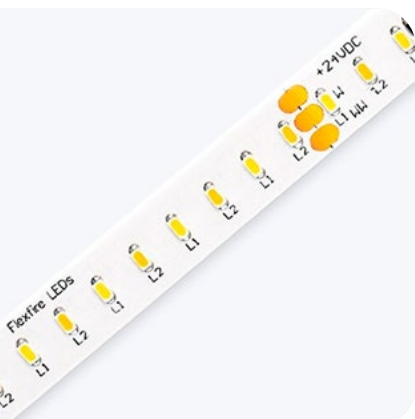

Architectural™ Dynamic Tunable White

The UltraBright™ Architectural Dynamic Tunable White Series offers countless color temperatures and high brightness so you can create the perfect light in any room, at any time. Pair it with a remote control system to take full advantage of the tunable capabilities.



Lumen Output:

Up to 494 lm/ft (1,621 lm/m)



Power:

4.4 W/ft (14.4 W/m)



CCT Range:

2700K - 6200K



Sienna™ Dim-to-Warm Series

Natural, seamless dimming for perfect lighting. As you dim your lights, the color temperature of the lights will automatically become warmer from 3000K to 1800K.



Lumen Output:

Up to 311 lm/ft (1,020 lm/m)



Power:

3.4 W/ft (11 W/m)



CCT Range:

3000K - 1800K

Accent™ Dynamic Tunable White Series



15-year
warranty



[> Visit Product Page](#)

Description

Our UltraBright™ Accent Dynamic Tunable White Series is the perfect choice for people who are looking for an accent lighting strip that will allow them to find the perfect shade of white. Choose from countless color temperatures between a wide range from 2700K to 6200K and enjoy full dimming capabilities to adjust the ambience of your space within seconds. With near-perfect color rendering and a long run length, these sophisticated lights are made to satisfy the desire for beauty and functionality.



Lumen Output:

Up to 266 lm/ft (872 lm/m)



Power:

3.5 W/ft (11.5 W/m)



CCT Range:

2700K - 6200K



Available IP Versions

Product Features

- Control strip to produce any color of white between 2700K and 6200K
- High CRI up to 99
- Up to 266 lm/ft (872 lm/m)
- Fully dimmable
- Highest quality components and premium packaged 2216 LEDs
- Single bin LED selection to ensure color consistency (3-Step MacAdam)
- Thermally resistant 3M VHB adhesive for long lasting bond
- 120° beam angle
- Efficacy up to 84 lm/W
- Width: 3/8" (10 mm) in IP20, 1/2" (12 mm) in IP65
- Short LED pitch of 3/16" (4 mm)
- 24V DC input voltage
- Can be cut every 2" (50 mm)
- Ambient temperature -4°F to 104°F (-20°C to 40°C)
- Thick double layer 4 oz copper PCB for excellent thermal management
- 73 LEDs/ft (240/m)
- Maximum run length in series: 39 ft (12 m)

Dimensions

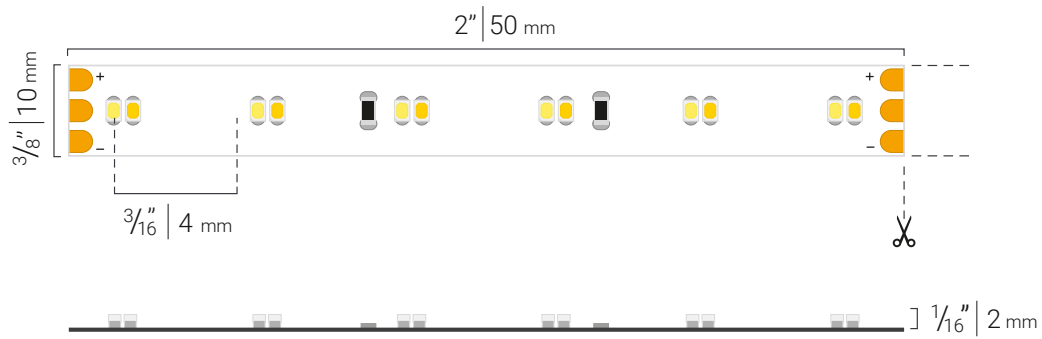

Specifications

Product SKU	Color (CCT)	Watts / Foot (Meter)	Lumen / Foot (Meter)	Luminous Efficacy (Lumens / Watt)	CRI	Gamut Score Rg (Color Sat.)	Relative Fidelity Score (RF)	TLCI (Qa)	CQS
UB-AT1-DYN2762 95C	2700K +6200K	3.5 W/ft (11.5 W/m)	266 lm/ft (872 lm/m)	75 lm/W	96	104	96	98	98
	2700K	1.7 W/ft (5.7 W/m)	122 lm/ft (401 lm/m)	68 lm/W	98	102	97	99	98
	6200K	1.7 W/ft (5.7 W/m)	149 lm/ft (488 lm/m)	84 lm/W	99	101	96	99	98

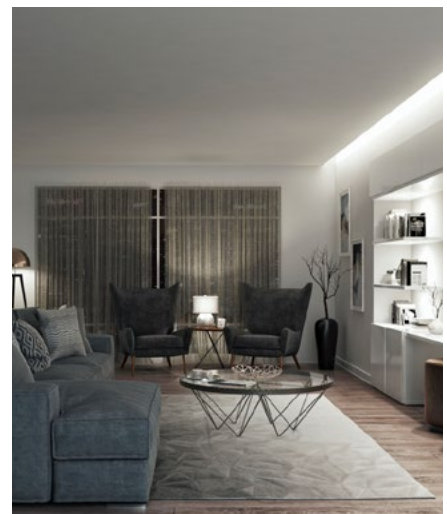

Architectural™ Dynamic Tunable White Series



15-year
warranty



[> Visit Product Page](#)

Description

Our UltraBright™ Architectural Dynamic Tunable White Series LED strip light is the go to strip for spaces requiring a high brightness output and an adjustable color temperature. With a wide range from 2700K all the way up to 6200K, you will be able to set the perfect shade of white for every moment of the day. The Architectural Dynamic Tunable White has a great color rendering index of up to 94, which will allow you to experience bright, vivid colors. This strip is perfect for cove lighting, architectural lighting, task lighting, and many more applications.



Lumen Output:

Up to 494 lm/ft (1,621 lm/m)



Power:

4.4 W/ft (14.4 W/m)



CCT Range:

2700K - 6200K



Available IP Versions

Product Features

- Control strip to produce any color of white between 2700K and 6200K
- High CRI up to 94
- Up to 494 lm/ft (1,621 lm/m)
- Fully dimmable
- Highest quality components and premium packaged 3014 LEDs
- Single bin LED selection to ensure color consistency (3-Step MacAdam)
- Thermally resistant 3M VHB adhesive for long lasting bond
- 120° beam angle
- Efficacy up to 108 lm/W
- Width: 3/8" (10 mm) in IP20, 1/2" (12 mm) in IP65
- Short LED pitch of 1/4" (6.3 mm)
- 24V DC input voltage
- Can be cut every 4" (101 mm)
- Ambient temperature -4°F to 104°F (-20°C to 40°C)
- Thick double layer 4 oz copper PCB for excellent thermal management
- 49 LEDs/ft (160/m)
- Maximum run length in series: 42 ft 7 in (13 m)

Dimensions

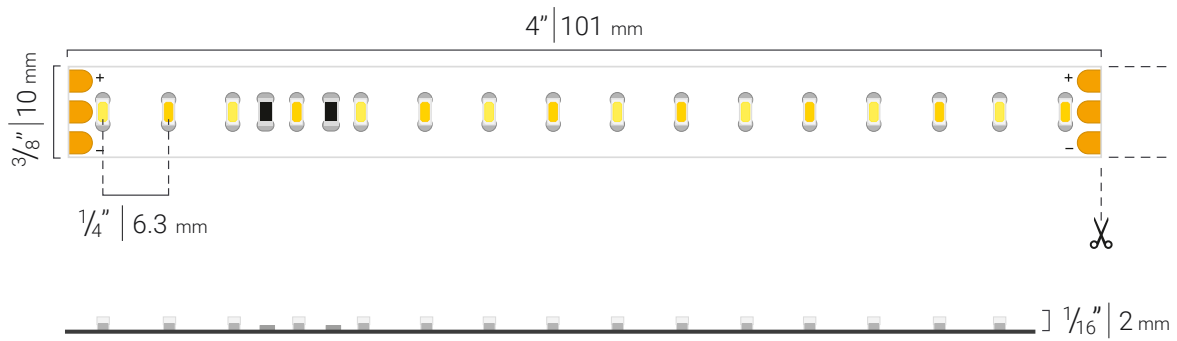

Specifications

Product SKU	Color (CCT)	Watts / foot (Meter)	Lumen / foot (Meter)	Luminous efficacy (Lumens / Watt)	CRI	Gamut Score Rg (Color Sat.)	Relative Fidelity Score (RF)	TLCI (Qa)	CQS
UB-AS-DYN2762 90C-24V	2700K +6200K	4.4 W/ft (14.4 W/m)	494 lm/ft (1,621 lm/m)	108 lm/W	93	96	88	87	90
	2700K	2.2 W/ft (7.2 W/m)	245 lm/ft (804 lm/m)	107 lm/W	94	96	89	87	93
	6200K	2.2 W/ft (7.2 W/m)	273 lm/ft (895 lm/m)	120 lm/W	93	100	88	93	90

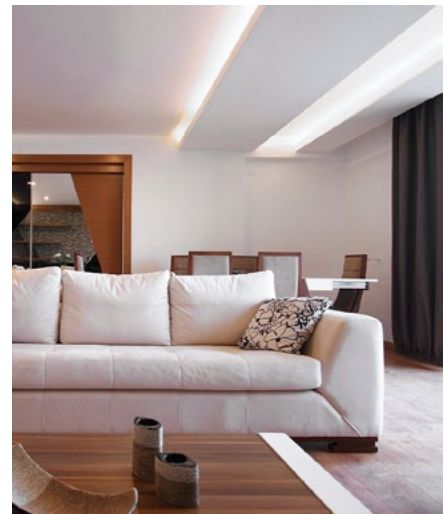

Sienna™ Dim-to-Warm Series



15-year warranty



[> Visit Product Page](#)



Description

Our UltraBright™ Sienna Dim-to-Warm Series creates more than beautiful light, it sets the tone and creates the perfect ambience to build new memories that last a lifetime. LED technology allows this dynamic strip to produce a candle-like glow similar to traditional incandescent lighting, but with innovative versatility and peak performance. As the lights dim, they automatically warm from 3000K to 1800K. The Sienna™ strip offers the cozy comfort of incandescent lighting while utilizing modern technology that can be used in almost any space.



Lumen Output:

Up to 311 lm/ft (1,020 lm/m)



Power:

3.4 W/ft (11 W/m)



CCT Warms as it Dims:

3000K - 1800K



Available IP Versions

Product Features

- High CRI up to 95
- Up to 311 lm/ft (1,020 lm/m)
- Highest quality components and premium packaged 2835 LEDs
- Single bin LED selection to ensure color consistency (3-Step MacAdam)
- Thermally resistant 3M VHB adhesive for long lasting bond
- 120° beam angle
- Efficacy up to 99 lm/W
- Width: 3/8" (10 mm) in IP20, 1/2" (12 mm) in IP65
- Short LED pitch of 1/8" (3.5 mm)
- 24V DC input voltage
- Can be cut every 3 3/8" (83.3 mm)
- Ambient temperature -4°F to 113°F (-20°C to 45°C)
- Thick double layer 4 oz copper PCB for excellent thermal management
- 51 LEDs/ft (168/m)
- Maximum run length in series: 16 ft (5 m)
- Compatible with most PWM, TRIAC, or 0/1-10V dimmers

Dimensions

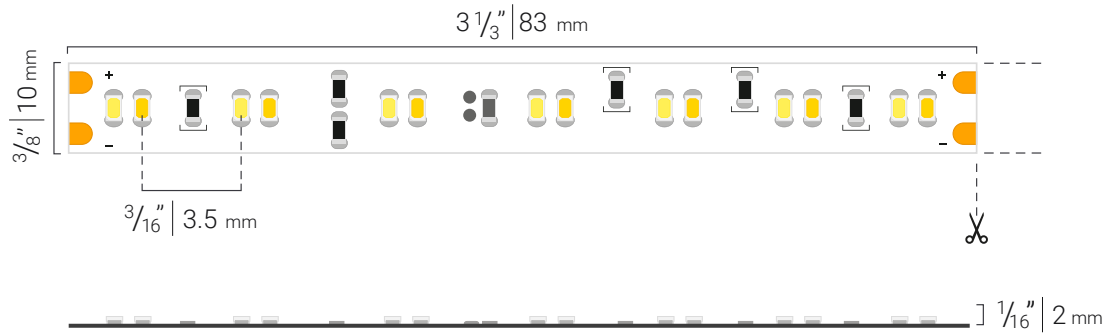





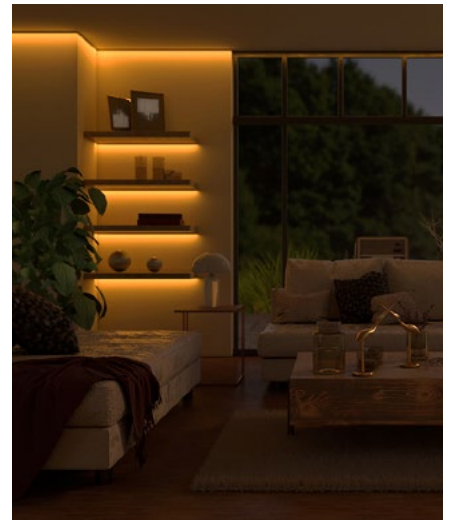

Specifications

Product SKU	Color (CCT)	Watts / foot (Meter)	Lumen / foot (Meter)	CRI	Gamut Score Rg (Color Sat.)	Relative Fidelity Score (RF)	TLCI (Qa)	CQS
UB-SNAD-W183090C	1800K	0.4 W/ft (1.3 W/m)	20 lm/ft (67 lm/m)	95	73	77	52	54
	3000K	3.4 W/ft (11 W/m)	311 lm/ft (1020 lm/m)	94	100	92	94	93



Dynamic Tunable White Strips Comparison Chart

LED Strip	Color Temperatures (CCT)	Brightness	Lumens / ft	Watts / ft	Lumens / Watt	Ingress Protection	CRI	Voltage	Max Run (in series)
 Accent™ Dynamic Tunable White Series	2700K - 6200K		~ 266	3.5	~ 84	IP20 IP65	~ 99	24V	39 ft
 Architectural™ Dynamic Tunable White Series	2700K - 6200K		~ 494	4.4	~ 108	IP20 IP65	~ 94	24V	42 ft
 Sienna™ Dim-to-Warm Series	1800K - 3000K		~ 311	3.4	~ 99	IP20 IP65	~ 95	24V	16 ft



Project Gallery

Dynamic Tunable White





Leestone Interiors

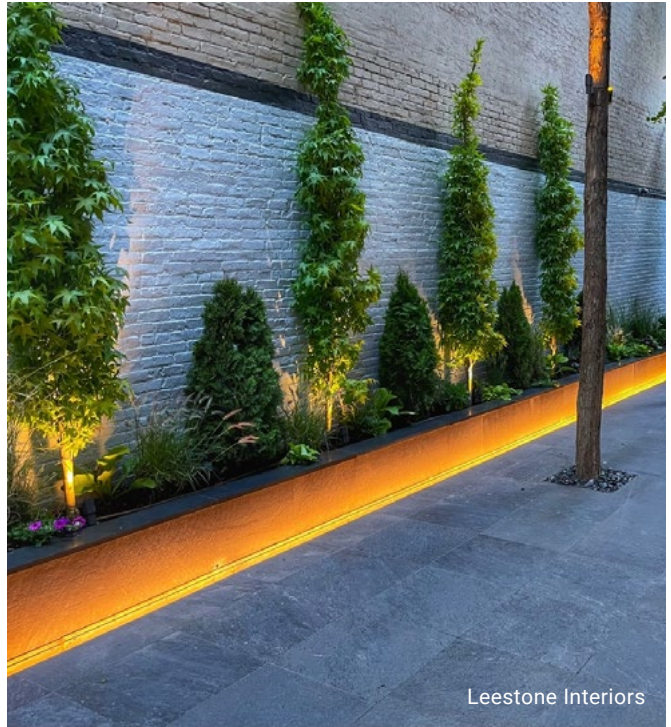

Leestone Interiors



Lobby Lighting

Outdoor Architectural™ Dynamic Tunable White Series



Patio Lighting

Outdoor Architectural™ Dynamic Tunable White Series



Under Cabinet Lighting

Architectural™ Dynamic Tunable White Series

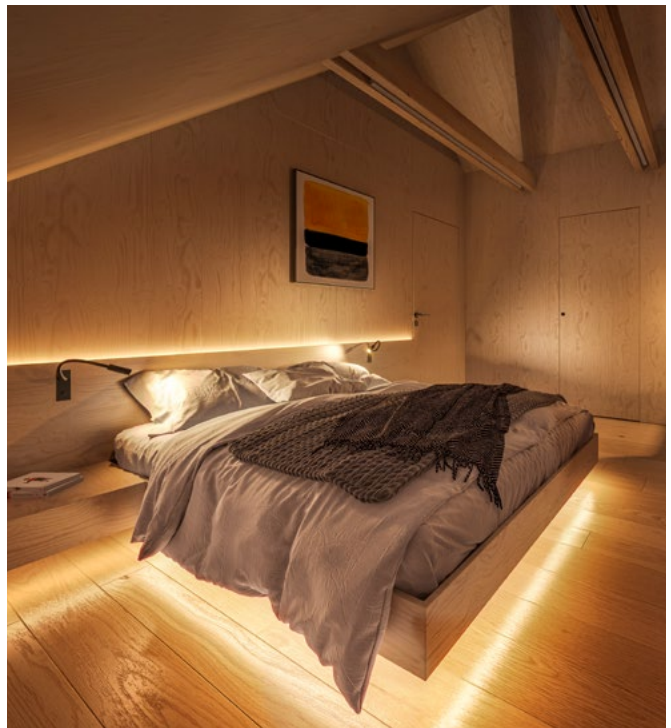

Raised Bed Lighting

Sienna™ Dim-to-Warm Series



RGB Color Changing LED STRIP LIGHTS



Our ColorBright™ RGB strip lights are the highest quality in the market with a warranty of up to 15 years. We believe in providing innovative solutions to transform your living spaces into unique pieces of functional art.



RGB 150 Series

This strip uses an advanced color mixing technology of 150 RGB color-changing LEDs per reel capable of creating millions of different color combinations, allowing you to create a soft accent hue of your choice.



9 LEDs/Foot

Perfect accent light



Power:

2.2 W/ft (7.2 W/m)



**Millions
of colors**



RGB 300 Series

The RGB 300 series utilizes the same technology as the RGB 150 series, but it has double the LEDs and double the brightness. This popular strip also allows you to create millions of colors, but its higher chip density creates an even brighter, beautiful glow.



18 LEDs/Foot

Uniform lines of light



Power:

4.4 W/ft (14.4 W/m)



**Millions
of colors**



RGB 600 Series

These LED strip lights are around 80% brighter than the ColorBright™ RGB 300. Overall, our ColorBright™ RGB 600 LED Strip Light is a next-generation RGB strip with improved features that contribute to a great quality of light.



36 LEDs/Foot

Seamless lines of light



Power:

6.1 W/ft (20 W/m)



**Millions
of colors**

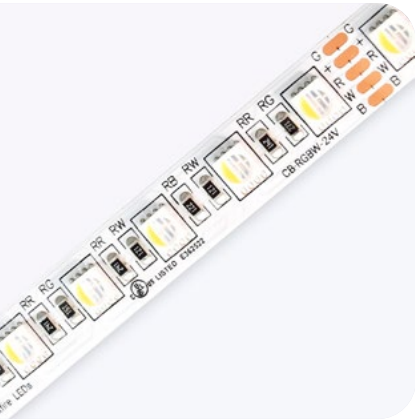

RGBW Color Changing + White Series

The ColorBright™ RGBW Quad Chip LED strip light is an ingenious product that combines two powerful strips into one. It features a 4-in-1 LED chip that produces both RGB color-changing and warm white lighting.



Lumen Output:

Up to 293 lm/ft (961 lm/m)



Power:

5.8 W/ft (19 W/m)



RGB + White

(3000K)



RGB Color Changing + Tunable White Series

Our ColorBright™ RGB + Dynamic Tunable White LED Strip Light combines two types of powerful strips into one, offering an RGB color-changing feature and a wide range of dynamic tunable white lighting that can be tuned from 2400K to 6500K.



Lumen Output:

Up to 260 lm/ft (853 lm/m)



Power:

5.5 W/ft (18 W/m)



RGB + Tunable White

(2400K - 6500K)

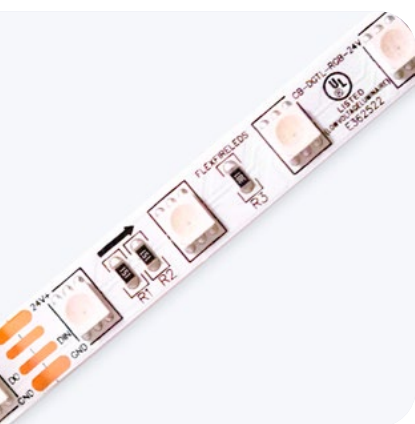

RGB Digital Pixel™ Series

This strip incorporates a small integrated circuit every 6 LEDs creating a Pixel, for a total of 50 pixels in a 5-meter reel. The ability to control those 50 pixels individually gives way to beautiful, dynamic, breathtaking effects.



**WS2811 IC
Protocol**



Power:

3.6 W/ft (12 W/m)



Colors:

RGB Pixels

RGB 150 Series



15-year
warranty



[> Visit Product Page](#)

Description

ColorBright™ Color Changing RGB 150 LED strip lights are linear color changing LED chips mounted on a flexible strip of printed circuit board (PCB) with a strong 3M adhesive backing. Using an RGB controller, you can change the color of your lights to almost anything you can imagine. Create beautiful works of art and light shows at the touch of a button.



9 LEDs/Foot

Perfect accent light



Power:

2.2 W/ft (7.2 W/m)



**Millions
of colors**



Available IP Versions

Product Features

- Fully dimmable and color controllable
- Highest quality components and premium packaged 5050 LEDs
- Thermally resistant 3M VHB adhesive for long lasting bond
- 120° beam angle
- Width: 3/8" (10 mm) in IP20, 1/2" (12 mm) in IP65
- Short LED pitch of 1 1/4" (33 mm)
- 24V DC input voltage
- Can be cut every 6 1/2" (165 mm)
- Ambient temperature -4°F to 104°F (-20°C to 40°C)
- Thick double layer 4oz copper PCB for excellent thermal management
- Maximum run length in series: 49 ft 2 in (15 m)

Dimensions

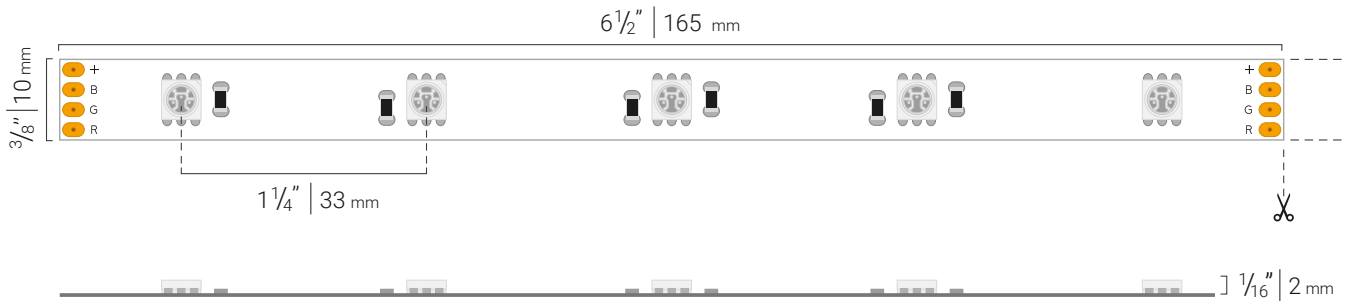

Specifications

Product SKU	LEDs / Foot (Meter)	Voltage Input	Watts / Foot (Meter)	Lumens / Foot (Meter)	Color Wavelengths (Nanometer)	Max. Run Length in Series
CB-RGB150-24V	9 LEDs/Foot (30/meter)	24V DC	2.2 W/ft (7.2 W/m)	R: 11LM (35/m) G: 46LM (150/m) B: 10LM (30/m)	R: 617-627 nm G: 515-525 nm B: 464-474 nm	49' 2" (15 meters)

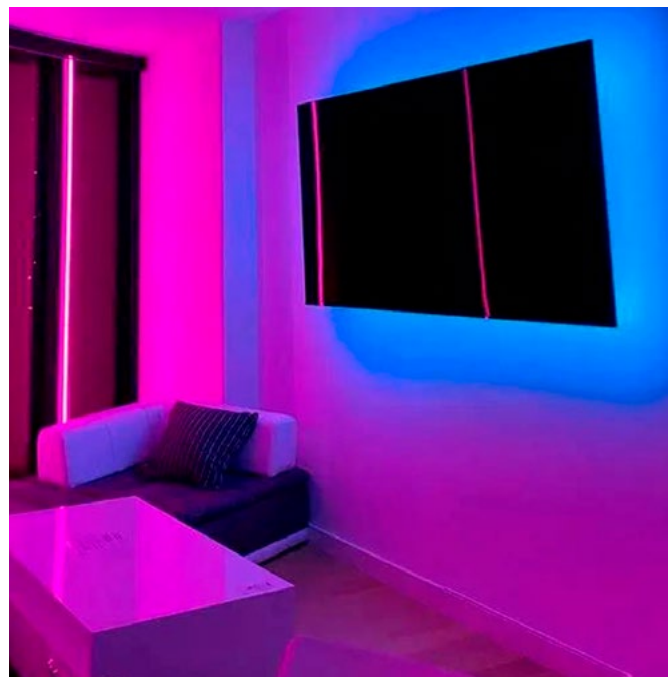

RGB 300 Series



15-year
warranty



[> Visit Product Page](#)

Description

ColorBright™ RGB 300 LED Strip Lights are perfect for applications that require not only adjustable color settings, but also bright lighting. This LED strip light offers bright colors, millions of possibilities, easy installations, and more. With 300 color-changing LED chips over a 5-meter reel, this LED strip creates a powerful line of light, thanks to its remarkable LED pitch of 3/4" (17 mm). Pair this strip with an RGB controller and these strips can change to nearly any color combination you could imagine, offering a wide range of creative options.



18 LEDs/Foot
Uniform lines of light



Power:
4.4 W/ft (14.4 W/m)



**Millions
of colors**



Available IP Versions

Product Features

- Fully dimmable and color controllable
- Highest quality components and premium packaged 5050 LEDs
- Thermally resistant 3M VHB adhesive for long lasting bond
- 120° beam angle
- Width: 3/8" (10 mm) in IP20, 1/2" (12 mm) in IP65
- Short LED pitch of 3/4" (17 mm)
- 12V or 24V DC input voltage
- 12V can be cut every 2" (50 mm)
- 24V can be cut every 4" (100 mm)
- Ambient temperature -4°F to 113°F (-20°C to 45°C)
- Thick double layer 4oz copper PCB for excellent thermal management
- Maximum run length in series:
16 ft (5 m) in 12V, 32 ft (10 m) in 24 V

Dimensions

12V

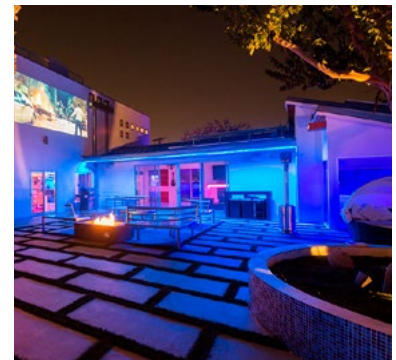
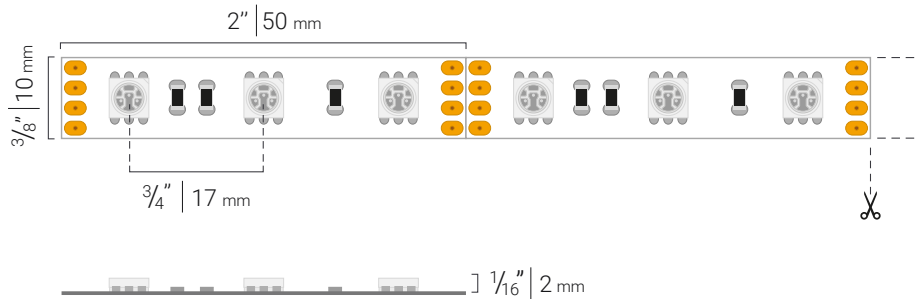

24V

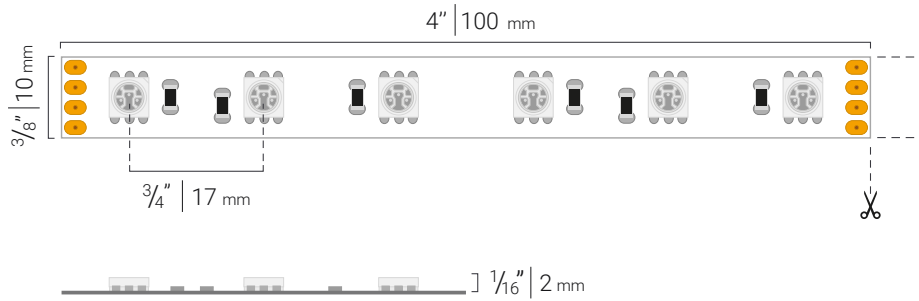

Specifications

Product SKU	LEDs / Foot (Meter)	Voltage Input	Watts / Foot (Meter)	Lumens / Foot (Meter)	Color Wavelengths (Nanometer)	Segment Lengths	Max. Run Length in Series
CB-RGB300-12V	18 LEDs/Foot (60/meter)	12V DC	4.4 W/ft (14.4 W/m)	151 lm/ft (495 lm/m)	R: 617-627 nm G: 515-525 nm B: 464-474 nm	2" (50 mm)	16' 5" (5 meters)
CB-RGB300-24V	18 LEDs/Foot (60/meter)	24V DC	4.4 W/ft (14.4 W/m)	151 lm/ft (495 lm/m)	R: 617-627 nm G: 515-525 nm B: 464-474 nm	4" (100 mm)	32' 10" (10 meters)

RGB 600 Series



7-year
warranty



[> Visit Product Page](#)



Description

ColorBright™ RGB 600 LED Strip Lights are ideal for projects that require the brightest, most colorful lighting, while also needing dynamic, versatile lights. Our ColorBright™ RGB 600 is one of the brightest RGB strips on the market, it emits rich and vibrant colors thanks to its thick, 3oz PCB, which also contributes to better heat dissipation and improved lifespan. Thanks to its 4040 LED chips and a tight LED pitch, our ColorBright™ RGB 600 LED Strip will create a robust line of light guaranteed to take your breath away. **Heat sink recommended.**



36 LEDs/Foot

Seamless lines of light



Power:

6.1 W/ft (20 W/m)



**Millions
of colors**



Available IP Versions

Product Features

- Fully dimmable and color controllable
- Highest quality components and premium packaged 4040 SMD LEDs
- Thermally resistant 3M VHB adhesive for long lasting bond
- 120° beam angle
- Width: 3/8" (10 mm) in IP20, 1/2" (12 mm) in IP65
- Short LED pitch of 5/16" (8 mm)
- 24V DC input voltage
- Can be cut every 2" (50 mm)
- Ambient temperature -4°F to 113°F (-20°C to 45°C)
- Thick double layer 3oz copper PCB for excellent thermal management
- Maximum run length in series: 26 ft (8 m)

Dimensions

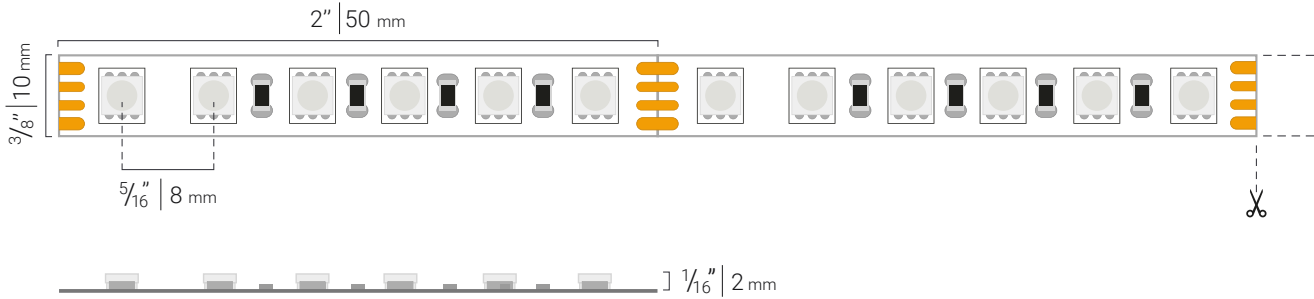

Specifications

Product SKU	LEDs / Foot (Meter)	Voltage Input	Watts / Foot (Meter)	Lumens / Foot (Meter)	Color Wavelengths (Nanometer)	Segment Lengths	Max. Run Length in Series
CB-RGB600-24V	36 LEDs/Foot (120/meter)	24V DC	6.1 W/ft (20 W/m)	231 lm/ft (759 lm/m)	R: 617-627 nm G: 520-530 nm B: 464-474 nm	2" (50 mm)	26 ft (8 meters)

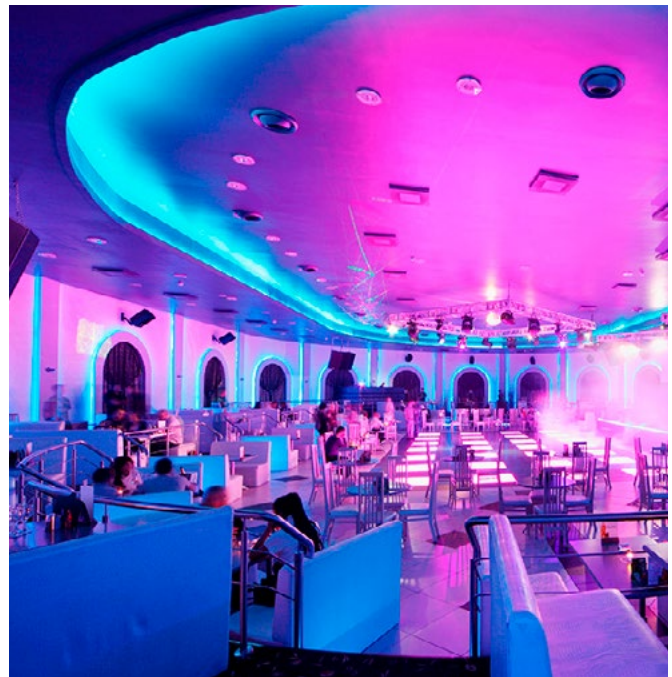
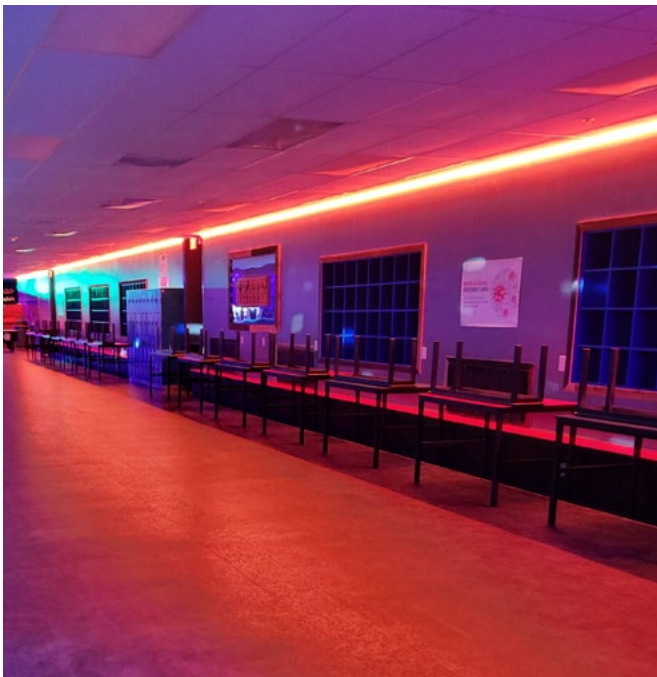

RGBW Color Changing + White Series



7-year
warranty



[> Visit Product Page](#)

Description

The ColorBright™ RGBW Quad Chip LED strip light is an ingenious product that has combined two powerful strips into one. Now featuring a 4-in-1 LED chip that produces both RGB color changing and warm white lighting. This new and improved strip is brighter, offers improved color rendering when using the white channel, and creates a more diffused appearance when paired with a diffuser compared to our previous RGBW strip. This product is perfect for those who love to control every aspect of their lighting. It is fully dimmable and can be set to many different modes depending on the controller they are paired with. Create multiple color combinations or set your lights to a beautiful warm white.



Lumen Output:

Up to 293 lm/ft (961 lm/m)



Power:

5.8 W/ft (19 W/m)



RGB + White

(3000K)



Available IP Versions

Product Features

- Fully dimmable and color controllable
- Highest quality components and premium packaged 5050 LEDs
- Single bin LED selection to ensure color consistency (3-Step MacAdam)
- Thermally resistant 3M VHB adhesive for long lasting bond
- 120° beam angle
- Width: 1/2" (12 mm) in IP20, 9/16" (14 mm) in IP65
- Short LED pitch of 5/16" (8.5 mm)
- 24V DC input voltage
- Can be cut every 3" (80 mm)
- Ambient temperature -4°F to 113°F (-20°C to 45°C)
- Thick double layer 4oz copper PCB for excellent thermal management
- Maximum run length in series: 32 ft 10 in (10 m)

Dimensions

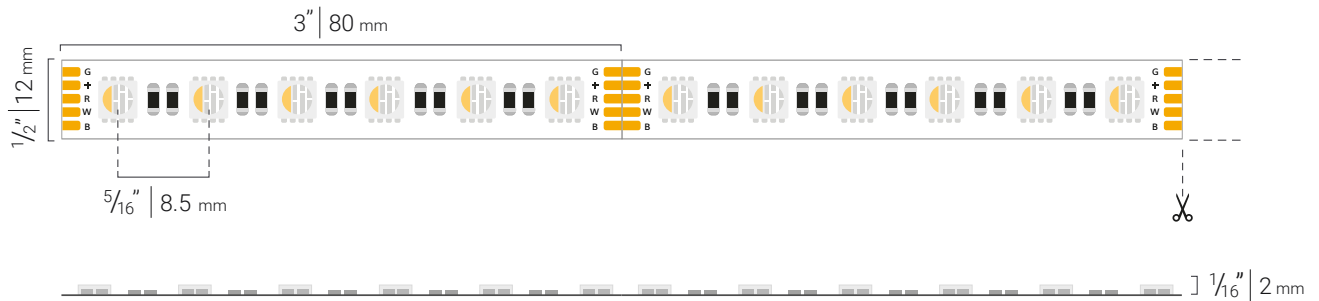

Specifications

Product SKU	Color (CCT)	Watts / Foot (Meter)	Lumen / Foot (Meter)	Luminous Efficacy (Lumens/Wat)	CRI	Gamut Score (Rg)	Relative Fidelity Score (Rf)	TLCI (Qa)
CB-RGBW	All channels on	5.8 W/ft (19 W/m)	293 lm/ft (961 lm/m)	52 lm/W	56	107	69	44
	3000K	1.4 W/ft (4.6 W/m)	121 lm/ft (397 lm/m)	79 lm/W	93	100	92	93

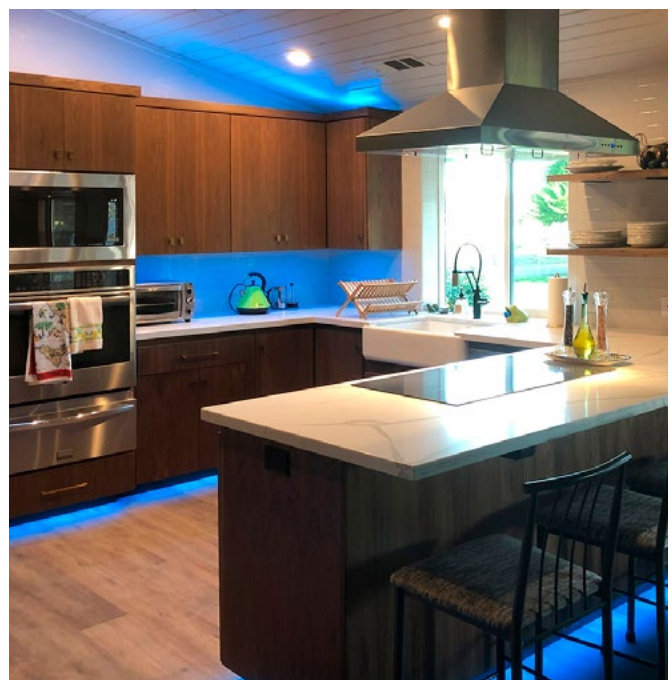

RGB Color Changing + Tunable White Series



7-year
warranty



[> Visit Product Page](#)

Description

Our ColorBright™ RGB + Dynamic Tunable White LED Strip Light really is an LED strip light for all occasions. Combining two strips in one, it allows for the creation of countless colors and multiple shades of white light in a smooth and vibrant line of light, thanks to its 5-in-1 5050 LED chips, which total 18 chips per foot. This product is for those who love to control every aspect of their lives, starting with their lights. Perfect for spaces that require the flexibility of multiple types of light.



Lumen Output:

Up to 260 lm/ft (853 lm/m)



Power:

5.5 W/ft (18 W/m)



RGB + Tunable White

(2400K - 6500K)



Available IP Versions

Product Features

- Millions of vivid colors + any shade of white
- Highest quality components and premium packaged 5050 LEDs
- Thermally resistant 3M VHB adhesive for long lasting bond
- 120° beam angle
- Width: 1/2" (12 mm) in IP20, 9/16" (14 mm) in IP65
- Short LED pitch of 3/4" (17 mm)
- 24V DC input voltage
- Can be cut every 4" (101 mm)
- Ambient temperature -4°F to 113°F (-20°C to 45°C)
- Thick double layer 3oz copper PCB for excellent thermal management
- Maximum run length with 3 channels on: 23 ft
- Maximum run length with all channels on: 16 ft

Dimensions



Specifications

Product SKU	Color (CCT)	Watts / Foot (Meter)	Lumen / Foot (Meter)	Luminous Efficacy (Lumens / Watt)	CRI	Gamut Score Rg (Color Sat.)	Relative Fidelity Score (RF)	TLCI (Qa)	CQS
CB-RGBDYN-2465K-24V-16FT	All Channels On	5.5 W/ft (18 W/m)	260 lm/ft (853 lm/m)	48 lm/W	64	109	75	56	82
	2400K	1.1 W/ft (3.6 W/m)	113 lm/ft (371 lm/m)	67 lm/W	94	100	93	92	94
	6500K	1.1 W/ft (3.6 W/m)	109 lm/ft (357 lm/m)	76 lm/W	95	97	89	94	91



RGB Digital Pixel™ Series



7-year warranty



[> Visit Product Page](#)

Description

Our ColorBright™ RGB Digital Pixel LED Strip Light incorporates a small integrated circuit every 6 LEDs creating a pixel, for a total of 50 pixels in a 5-meter reel. The ability to control those 50 pixels individually gives way to beautiful, dynamic, breath-taking effects, which are perfect for commercial and entertainment environments. You will have complete control over your digital pixel LED strip when paired with a digital LED controller, you will be able to create chasing effects, while also being able to adjust the brightness, speed and direction of the pixels.



**WS2811 IC
Protocol**



Power:
3.6 W/ft (12 W/m)



Colors:
RGB Pixels



Available IP Versions

Product Features

- Fully dimmable and color controllable
- SPI controlled
- 50 pixels (6 LEDs per Pixel)
- Highest quality components and premium packaged 5050 SMD LEDs
- Thermally resistant 3M VHB adhesive for long lasting bond
- 120° beam angle
- Width: 3/8" (10 mm) in IP20, 1/2" (12 mm) in IP65
- Short LED pitch of 7/16" (11 mm)
- 24V DC input voltage
- Can be cut every 4" (100 mm)
- Ambient temperature -4°F to 113°F (-20°C to 45°C)
- Thick double layer 3oz copper PCB for excellent thermal management
- Maximum run length: 32 ft (10 m)

Dimensions

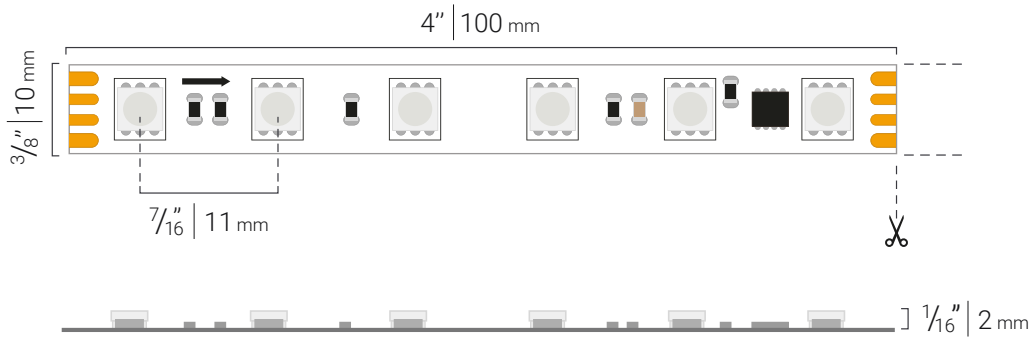

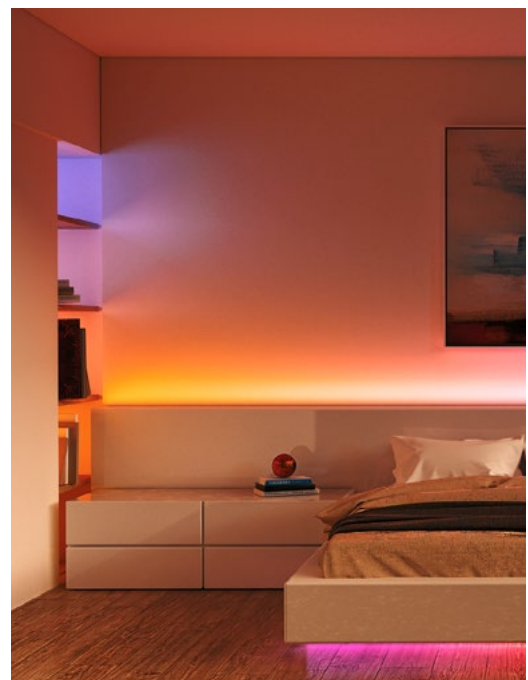
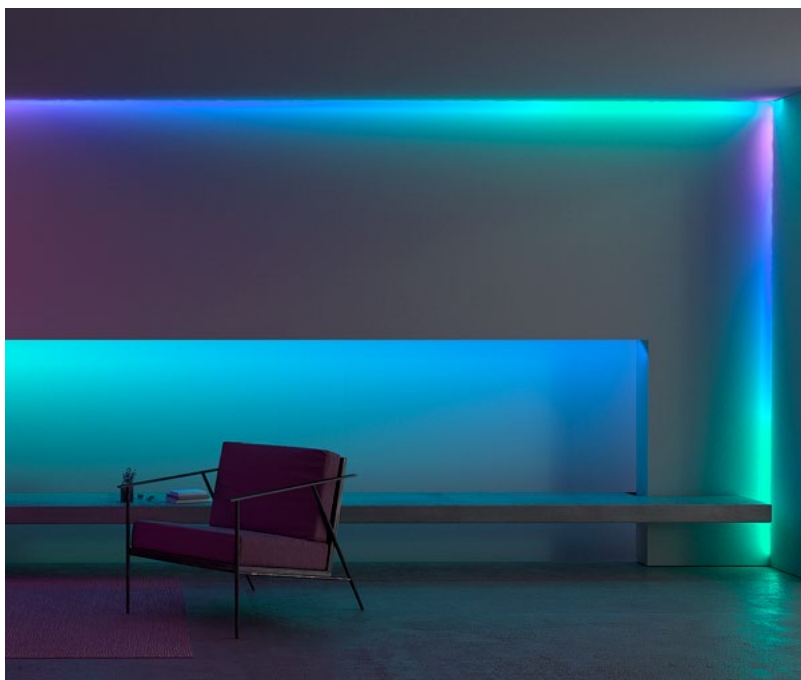

Specifications

Product SKU	LED Chips per Pixel	Voltage Input	Watts / foot (Meter)	Watts / Meter	Lumens / Foot	Lumens / Meter	Luminous Efficacy
CB-DGTL-RGB-24V-16FT	6	24V DC	3.65 W/ft	12 W	107 lm/ft	350 lm/m	29 lm/w



RGB Strips Comparison Chart

LED Strip	Color Temperatures (CCT)	Brightness	Lumens / ft	Watts / ft	Ingress Protection	CRI	Voltage	Max Run (in series)
 RGB 150 Series	 RGB		N.A.	2.2	IP20 IP65	N.A.	24V	48 ft
 RGB 300 Series	 RGB		N.A.	4.4	IP20 IP65	N.A.	12V 24V	16 ft 32 ft
 RGB 600 Series	 RGB		~ 231	6.1	IP20 IP65	N.A.	24V	26 ft
 RGBW Color Changing + White	 RGB + 3000K		~ 293	5.8	IP20 IP65	~ 93	24V	32 ft
 RGB + Tunable White Series	 RGB + 24K - 65K		~ 260	5.5	IP20 IP65	~ 95	24V	23 ft
 RGB Digital Pixel™ Series	 RGB Pixel		N.A.	3.6	IP20 IP65	N.A.	24V	32 ft



Project Gallery

RGB Color Changing

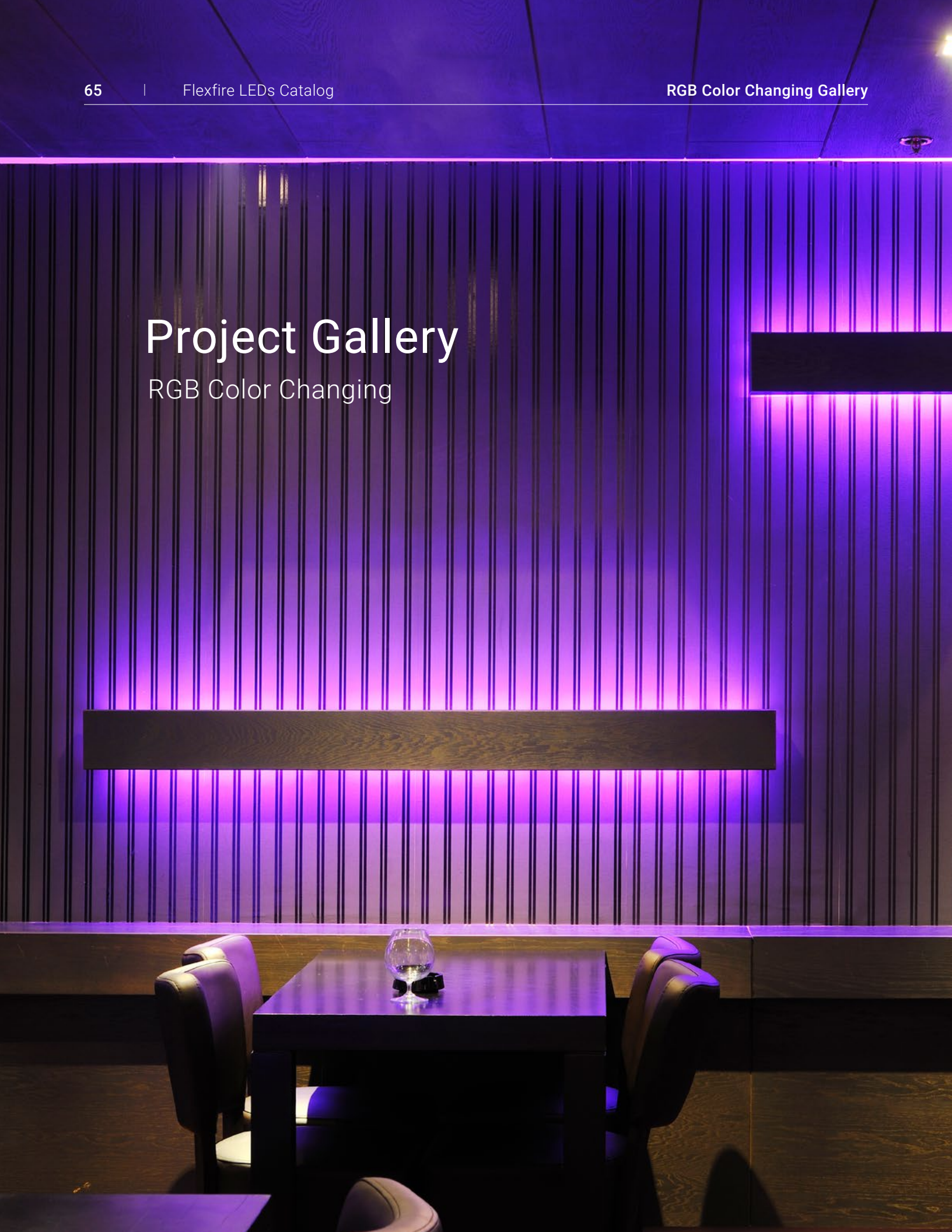



Backyard Lighting

Outdoor RGB 300 Series



Bar and Restaurant Lighting

RGB + Dynamic Tunable White Series



Bar and Restaurant Lighting

RGB 300 Series

**Studio Lighting**

RGB 150 Series

**Ceiling Lighting**

RGBW Color Changing + White Series



Single Color

LED STRIP LIGHTS



Vivid, high saturation accent lighting. Available in Red, Blue, Green, Amber & Ultraviolet (UV).



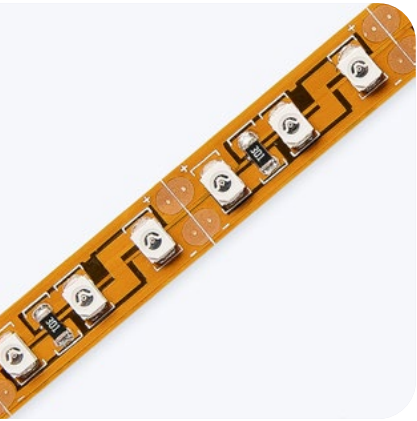

ColorBright™ Vivid Color Series

ColorBright™ Vivid Color LED strip lights are the perfect way to add a splash of beautiful colored lighting in compact places. The flexible design of LED strips allows for the addition of red, green, blue, or amber in practically any space.



Power:

2.9 W/ft (9.6 W/m)



Red:

615 - 630 nm



Amber:

596 nm



Green:

515 - 525 nm



Blue:

465 - 475 nm



ColorBright™ Ultraviolet Series

ColorBright™ Ultraviolet LED strip lights are linear UV LED chips mounted on a flexible strip of printed circuit board (PCB) with a strong adhesive backing. The flexible design of LED strips allows for the addition of UV light to basically any space.



Power:

2.9 W/ft (9.6 W/m)



UV-A:

399 nm

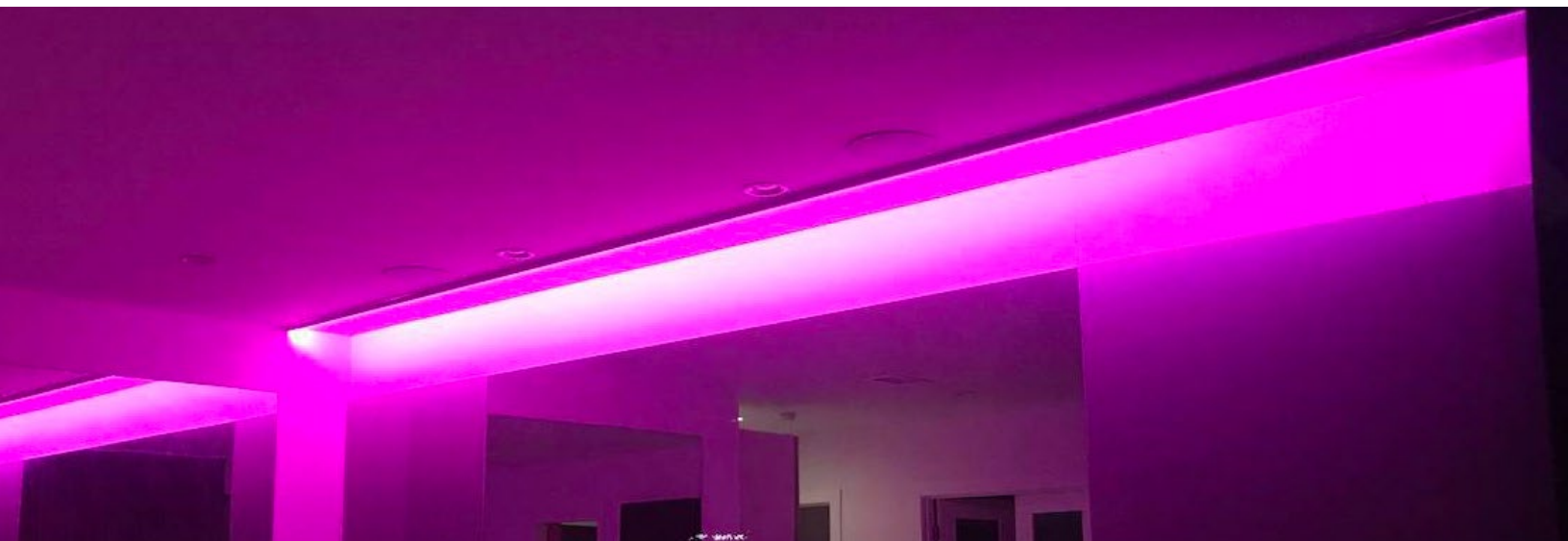

ColorBright™ Vivid Color Series



15-year
warranty



[> Visit Product Page](#)

Description

The ColorBright™ Vivid Color Series is a single color output LED strip light that comes in 4 different options: red, amber, blue, and green. This strip is perfect for projects requiring a single but bright color output of the aforementioned. Add touches of beautiful, bright colors almost anywhere you can imagine in residential or commercial applications.



Power:

2.9 W/ft (9.6 W/m)



Red:

615 - 630 nm



Amber:

596 nm



Green:

515 - 525 nm



Blue:

465 - 475 nm



Available IP Versions

Product Features

- High brightness output
- Fully dimmable
- Highest quality components and premium packaged 3528 LEDs
- Thermally resistant 3M VHB adhesive for long lasting bond
- 120° Beam Angle
- Width: 5/16" (8 mm) in IP20, 5/8" (10 mm) in IP65
- Short LED pitch of 5/16" (8 mm)
- 12V DC input voltage
- Can be cut every 1" (25.4 mm)
- Ambient temperature -4°F to 104°F (-20°C to 40°C)
- Thick double layer 2oz copper PCB for excellent thermal management
- 36 LEDs/ft (120/m)
- Maximum length in series: 32 ft 10 in (10 m)

Dimensions

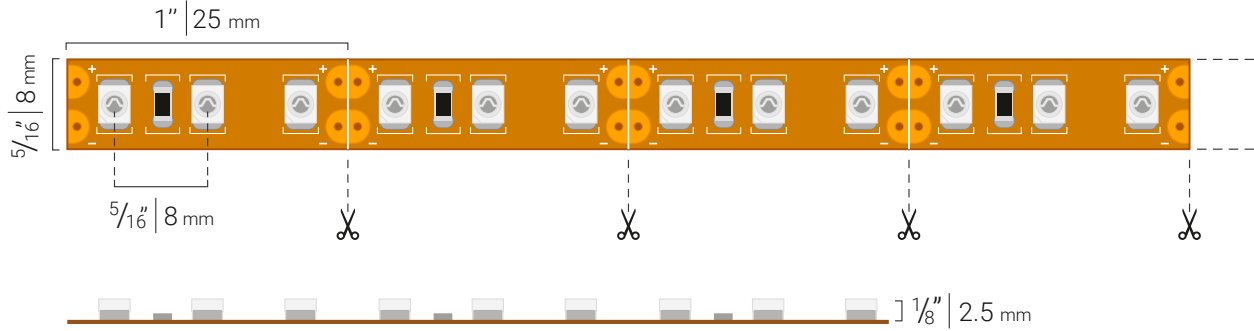

Specifications

Product SKU	Color (CCT)	Wavelength (nm)	Watts / Foot (Meter)	Lumin. Flux (Meter)	Luminous Efficacy (Lumens / Watt)
CB-R	Red	615 - 630 nm	2.9 W/ft (9.6 W/m)	91 lm/ft (300 lm/m)	31
CB-AM	Amber	575 nm (1600 - 1800K)	2.9 W/ft (9.6 W/m)	263 lm/ft (862 lm/m)	91
CB-G	Green	515 - 525 nm	2.9 W/ft (9.6 W/m)	134 lm/ft (440 lm/m)	46
CB-B	Blue	465 - 475 nm	2.9 W/ft (9.6 W/m)	55 lm/ft (180 lm/m)	19



ColorBright™ Ultraviolet Series



15-year
warranty



[> Visit Product Page](#)

Description

ColorBright™ Ultraviolet LED strip lights are linear UV-A LED chips mounted on a flexible strip of printed circuit board (PCB) with a strong adhesive backing. Though they are not extremely powerful LEDs, they are not meant to be directly stared into for prolonged periods of time. **Please read about UV LED eye safety procedures before installing and using this strip.**



Power:

2.9 W/ft (9.6 W/m)



UV-A:

399 nm



Available IP Versions

Product Features

- Fully dimmable
- Highest quality components and premium packaged 3528 LEDs
- Thermally resistant 3M VHB 4930 adhesive for long lasting bond
- 120° beam angle
- Efficacy up to 92 lm/W
- Only 5/16" (8 mm) strip width
- Short LED pitch of 5/16" (8 mm)
- 12V DC input voltage
- Can be cut every 1" (25.4 mm)
- Ambient temperature -4°F to 104°F (-20°C to 40°C)
- Thick double layer 2oz copper PCB for excellent thermal management
- 36 LEDs/ft (120/m)
- Maximum length in series: 32 ft 10 in (10 m)

Dimensions

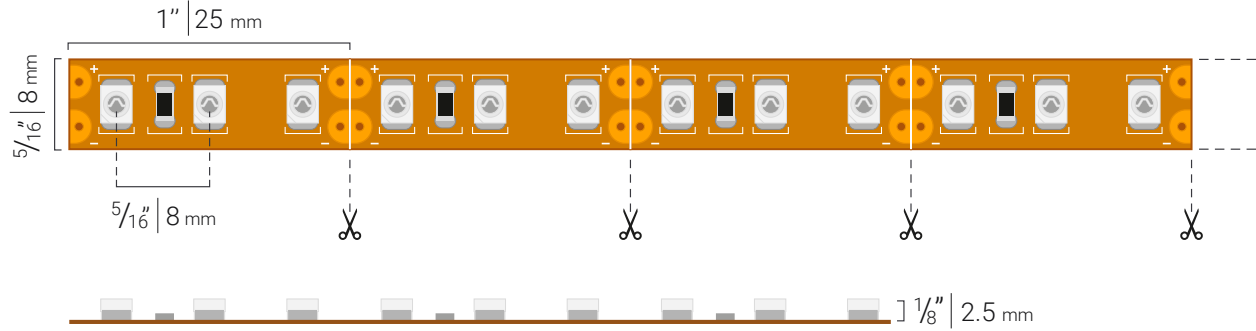

Specifications

Product SKU	Color (CCT)	Wavelength (nm)	Watts / Foot (Meter)	Irradiance
CB-UV	Ultraviolet	365 nm - 460 nm (peak wavelength at 399nm)	2.9 W/ft (9.6 W/m)	At 1 cm from the LED chip = 10 W/cm ²

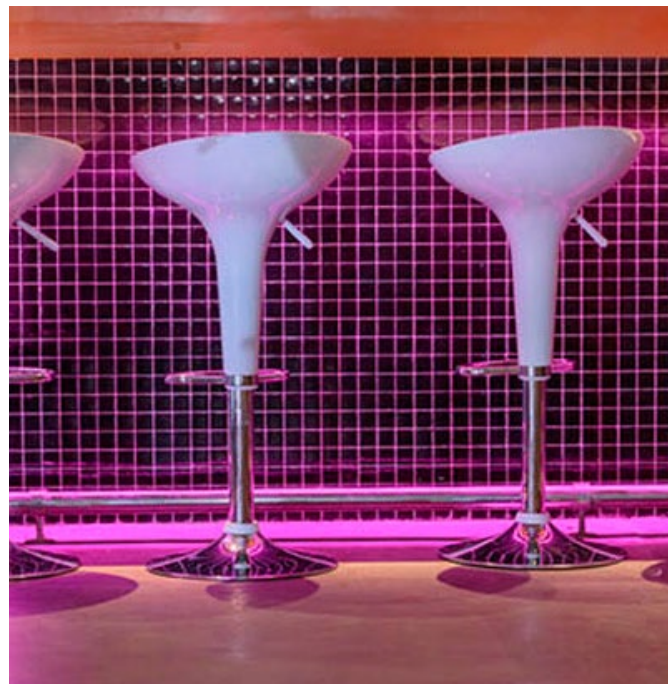

Single Color Strips Comparison Chart



LED Strip	Colors	Brightness	Lumens / ft	Watts / ft	Lumens / Watt	Ingress Protection	Voltage	Max Run (in series)
 Vivid Color Red	Red (615 - 630 nm)		91	2.9	42	IP20 IP65	12V	32 ft
 Vivid Color Amber	Amber (596 nm)		263	2.9	91	IP20 IP65	12V	32 ft
 Vivid Color Green	Green (515 - 525 nm)		134	2.9	31	IP20 IP65	12V	32 ft
 Vivid Color Blue	Blue (465 - 475 nm)		55	2.9	11	IP20 IP65	12V	32 ft
 Ultraviolet 399 nm	UV (399 nm)		N.A.	2.9	N.A.	IP20	12V	32 ft



Lucid™

FLEXIBLE NEON LED STRIP LIGHTS

Side bending strip lights that emulate neon lighting. Available in RGB and white versions.





Lucid™ Flexible LED Neon Strip Light

Our Lucid™ LED Neon Strip Lights are ideal for accent applications, signs, wall lighting, landscape lighting, and areas where lighting is embedded into a surface; among many others. These strip lights emulate the effect of a neon light.



Power:
2.7 W/ft



Static White:
3000K or 5000K



Lucid™ RGB Flexible LED Neon Strip Light

Our Lucid™ RGB LED Neon Strip Lights create beautiful colors for accent applications. These strip lights emulate the effect of a neon light, creating a continuous, lustrous line of light, offering many improvements over traditional neon lighting.



Power:
2.7 W/ft



RGB:
Color Changing



Lucid™ Flexible LED Neon Strip Light



7-year
warranty



[> Visit Product Page](#)

Description

Our Lucid™ LED Neon Strip Lights are ideal for accent applications, signs, wall lighting, landscape lighting, and areas where lighting is embedded into a surface; among many others. These strip lights emulate the effect of a neon light, creating a continuous, lustrous line of light, offering many improvements over traditional neon lighting. The IP65 rating means that the Lucid™ LED Neon Strip Lights are able to withstand jets and splashes of water from all sides. It cannot be submerged in water, but it will withstand the elements. We also recommend them for indoor use in high splash areas or if you're looking for a strip that is easier to clean.



Power:
2.7 W/ft



Static White:
3000K or 5000K



Side-Bending:
4¾" Maximum Bending Diameter



Fully Diffused:
Continuous Line of Light



Product Features

- Fully dimmable
- Up to 155 lm/ft (510 lm/m)
- Width (at the base): 3/8" (10 mm)
- Height: 7/8" (20 mm)
- Maximum lateral bending diameter: 4 3/4" (120 mm)
- 3014 LED chips
- 160° beam angle
- Efficacy up to 56 lm/W
- 24V DC input voltage
- Can be cut every 2" (50 mm)
- Ambient temperature: -4°F to 113°F (-20°C to 45°C)
- 50,000 hour lifespan (8 hours a day for 17 years)
- IP65 rated
- Maximum run length in series: 32 ft 10 in (10 m)

Dimensions



Specifications

Product SKU	Color (CCT)	Watts / Foot (Meter)	Lumen / Foot (Meter)	Luminous Efficacy (Lumens / Watt)	CRI	Gamut Score Rg (Color Sat.)	TLCI (Qa)	CQS
LUC-S-30K-24V-32FT	3000K	2.7 W/ft (9 W/m)	144 lm/ft (473 lm/m)	52 lm/W	83	94	75	85
LUC-S-50K-24V-32FT	5000K	2.7 W/ft (9 W/m)	155 lm/ft (510 lm/m)	56 lm/W	83	95	73	83

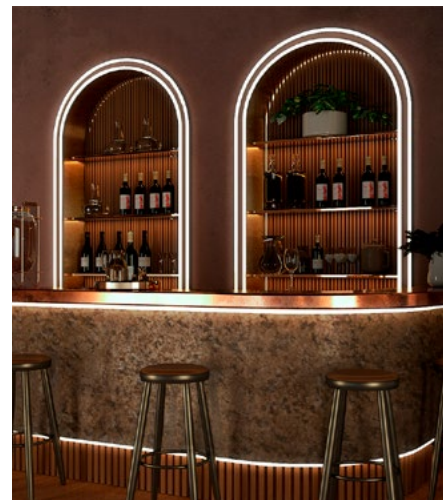

Lucid™ RGB Flexible LED Neon Strip Light



7-year
warranty



[> Visit Product Page](#)

Description

Our Lucid™ RGB LED Neon Strip Lights create beautiful colors for accent applications, signs, wall lighting, landscape lighting, and areas where lighting is embedded into a surface; among many others. These strip lights emulate the effect of a neon light, creating a continuous, lustrous line of light, offering many improvements over traditional neon lighting. The IP65 rating means that the Lucid™ RGB LED Neon Strip Lights are able to withstand jets and splashes of water from all sides. They cannot be submerged in water, but will withstand the elements. We also recommend them for indoor use in high splash areas or if you're looking for a strip that is easier to clean.



Power:
2.7 W/ft



RGB:
Color Changing



Side-Bending:
4 3/4" Maximum Bending Diameter



Fully Diffused:
Continuous Line of Light



Product Features

- Fully dimmable and color controllable
- Up to 42 lm/ft (138 lm/m)
- Width (at the base): 3/8" (10 mm)
- Height: 7/8" (20 mm)
- Maximum lateral bending diameter: 4 3/4" (120 mm)
- 3014 LED chips
- 160° beam angle
- Efficacy up to 13.8 lm/W
- 24V DC input voltage
- Can be cut every 2" (50 mm)
- Ambient temperature: -4°F to 113°F (-20°C to 45°C)
- 50,000 hour lifespan (8 hours a day for 17 years)
- IP65 rated
- Maximum run length in series: 32 ft 10 in (10 m)

Dimensions



Specifications

Product SKU	Color (CCT)	Watts / Foot (Meter)	Lumen / Foot (Meter)	Wavelengths	Max Run Length in Series
LUC-S-RGB-24V-32FT	RGB	2.7 W/ft	42 lm/ft (138 lm/m)	R: 620-630 nm G: 520-530 nm B: 460-470 nm	32' 10" (10 m)

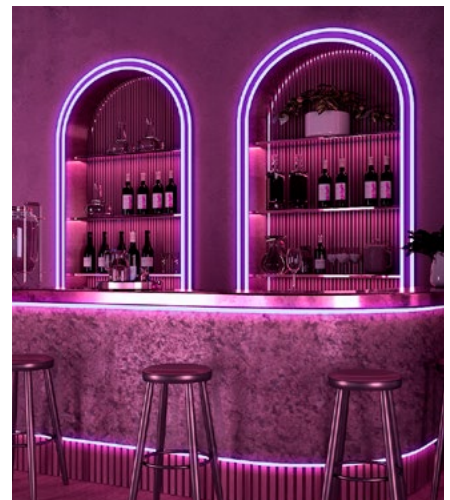
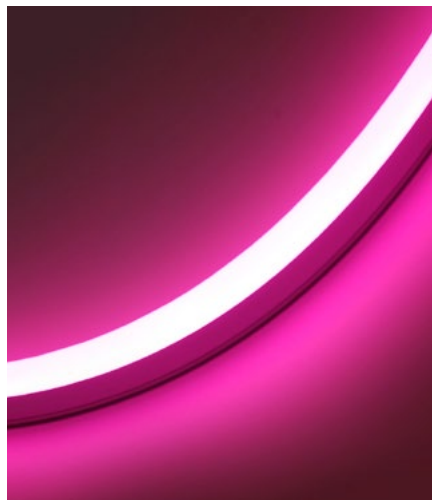

Valor™

IP67 PREMIER DIFFUSION SERIES

The highest output outdoor LED strip light option that provides clean and continuous lines of light.

Valor™ IP67 Premier Diffusion Series



7-year
warranty



[> Visit Product Page](#)

Description

The Valor™ Premier Diffusion Series LED Strip Light is ideal for applications needing bright, fully-diffused lighting, or high-output lighting in outdoor settings, such as commercial projects, hallways, outdoor coves, and outdoor corridors, among other architectural projects. Its 93 LED chips per meter and its silicone sleeve are combined to offer full diffusion and a beautiful seamless line of light. It also offers optimal light quality, with a CRI over 90 and a low profile form factor.



Lumen Output:

Up to 805 lm/ft (2,642 lm/m)



Power:

7.3 W/ft (24 W/m)



Static White:

3000K or 5000K



Fully Diffused:

Continuous Line of Light



Product Features

- High CRI up to 94
- Up to 805 lm/ft (2,642 lm/m)
- Fully dimmable
- Highest quality components and premium packaged 2835 LEDs
- Single bin LED selection to ensure color consistency (3-Step MacAdam)
- Thermally resistant 3M GL 9495 adhesive for long lasting bond
- 120° beam angle
- Efficacy up to 119 lm/W
- Width: 1/2" (12 mm)
- Height: 1/4" (5 mm)
- 24V DC input voltage
- Can be cut every 1" (25 mm)
- Ambient temperature: -4°F to 113°F (-20°C to 45°C)
- 93 LEDs/ft (308 LEDs/m)
- Maximum run length in series: 16 ft (5 m)

Dimensions

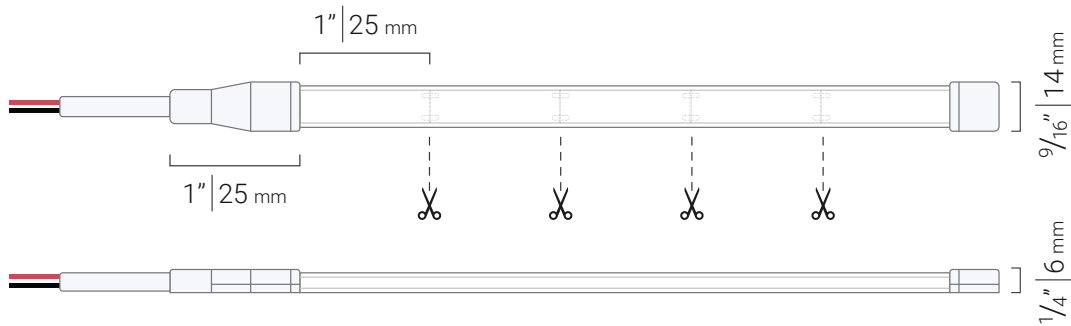

Specifications

Product SKU	Color (CCT)	Watts / Foot (Meter)	Lumen / Foot (Meter)	Luminous Efficacy (Lumens / Watt)	CRI	Gamut Score Rg (Color Sat.)	Relative Fidelity Score (RF)	TLCI (Qa)	CQS
IP67-UB-VA-30K	3000K	7.3 W/ft 24 W/m	750 lm/ft (2,460 lm/m)	110 lm/W	94	99	92	95	93
IP67-UB-VA-50K	5000K	7.3 W/ft 24 W/m	805 lm/ft (2,642 lm/m)	119 lm/W	94	98	90	95	91



ClickBright™

LINKABLE LED LIGHT BARS

The perfect lighting solution for anyone wanting a quick and easy, high-quality installation option.



ClickBright™ LED Light Bars



5-year
warranty



[> Visit Product Page](#)

Description

ClickBright™ Light Bars provide a simple and effective lighting solution perfect for projects requiring a mid-output light versatile enough to work as task lighting and accent lighting. These bars can be linked up to 16 feet continuously or 10 connections, and can be installed with L connectors to go around corners without interrupting the line of light. The cover on these bars guarantees a smooth, spotless line of light that can also be dimmed as needed. These bars are lightweight yet durable and have a 5-year warranty.

Easy Set Up in Minutes



Click



Bright

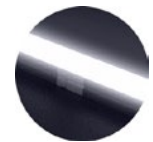

That's it!



Lumen Output:

493 lm in 1 ft
917 lm in 2 ft



Power:

4.3 W in 1 ft
8.6 W in 2 ft



Color Temperatures:

27K, 30K, 35K, 40K, 50K

IP20

Product Features

- Bars available in 1ft (30 cm) or 2ft (58 cm)
- High CRI up to 98
- High TLCI up to 98
- Efficacy up to 104 lm/W
- 24V DC input
- 4014 SMD chips
- 48 LEDs per foot
- IP20 indoor-rated
- Width: ½" (12.6 mm) / Height: ⅜" (10 mm)
- 50,000 hour lifespan (8 hours/day for 17 years)
- Operating temperature: -4°F to 104°F (-20°C to 40°C)
- 120° beam angle

Dimensions

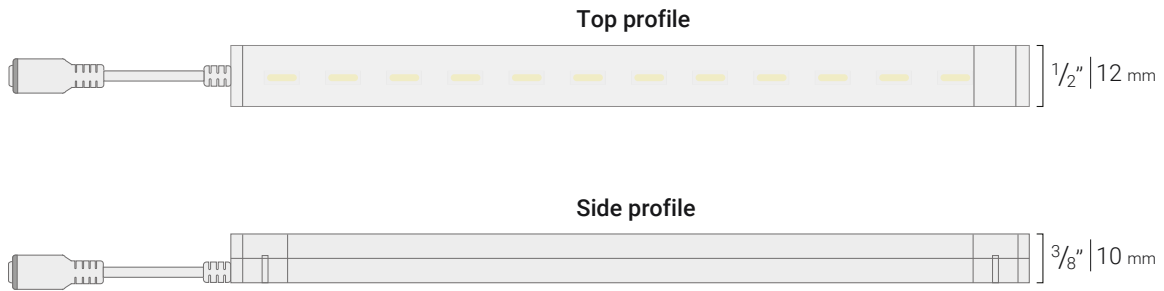

Specifications

Product SKU	Color (CCT)	Fixture Length	Watts / Fixture	Lumens / Fixture	Luminous Efficacy (Lumens / Watt)	CRI	Gamut Score Rg (Color Sat.)	Relative Fidelity Score (RF)	TLCI (Qa)	CQS
CLK-01-27K	2700K	1ft (30cm)	4.3 W/fixture	416 lm/fixture	83 lm/W	98	100	95	98	98
		2ft (58cm)	8.6 W/fixture	735 lm/fixture	81 lm/W	94	99	92	94	94
CLK-01-30K	3000K	1ft (30cm)	4.3 W/fixture	404 lm/fixture	90 lm/W	94	98	92	94	94
		2ft (58cm)	8.6 W/fixture	856 lm/fixture	93 lm/W	96	98	91	97	94
CLK-01-35K	3500K	1ft (30cm)	4.3 W/fixture	478 lm/fixture	105 lm/W	95	98	91	97	93
		2ft (58cm)	8.6 W/fixture	917 lm/fixture	105 lm/W	98	100	95	98	98
CLK-01-40K	4000K	1ft (30cm)	4.3 W/fixture	446 lm/fixture	96 lm/W	94	99	92	94	94
		2ft (58cm)	8.6 W/fixture	870 lm/fixture	97 lm/W	94	98	92	94	94
CLK-01-50K	5000K	1ft (30cm)	4.3 W/fixture	493 lm/fixture	103 lm/W	96	98	91	97	94
		2ft (58cm)	8.6 W/fixture	900 lm/fixture	104 lm/W	95	98	91	97	93



Endeavor™

120V COVE FIXTURE

With rotating mounting clips and selectable CCT the Endeavor™ is a versatile lighting fixture that is able to run long distances thanks to its input voltage of 120V AC.

Endeavor™ 120V Cove Fixture



5-year
warranty



[> Visit Product Page](#)

Description

The Endeavor™ 120V Cove Fixture features rotating mounting clips which makes it ideal for several types of spaces where you want to be able to throw your light at the perfect angle. The selectable CCT feature on the side of the fixture allows you to choose between three different shades of white to ensure that you are able to purchase multiple fixtures at once while still having the right light for any job site.

Because this fixture runs off of 120V AC power, it is able to run long distances and can be chained together for up to 300W of continuous bars before experiencing any kind of voltage drop. Its easy installation lends itself to work well in retrofit applications that may have previously housed linear fluorescent lighting.



Lumen Output:

1,043 lm in 1 ft
1,960 lm in 2 ft



Power:

10 W in 1 ft
20 W in 2 ft



Selectable White:

Can be set to
30K, 35K & 40K



Premium Diffusion:

Continuous
Line of Light

IP20

Product Features

- Fixtures available in 1 ft (30 cm) or 2 ft (58 cm)
- High CRI up to 93
- Fully dimmable
- 120° beam angle
- Width: 1" (28 mm)
- Height: 1" (25 mm)
- Efficacy up to 104 lm/W
- 120V AC input voltage / 50~60 Hz
- Ambient temperature: -4°F to 122°F (-20°C to 50°C)
- Maximum run length: 300W chained (~30 ft of fixtures)

Dimensions

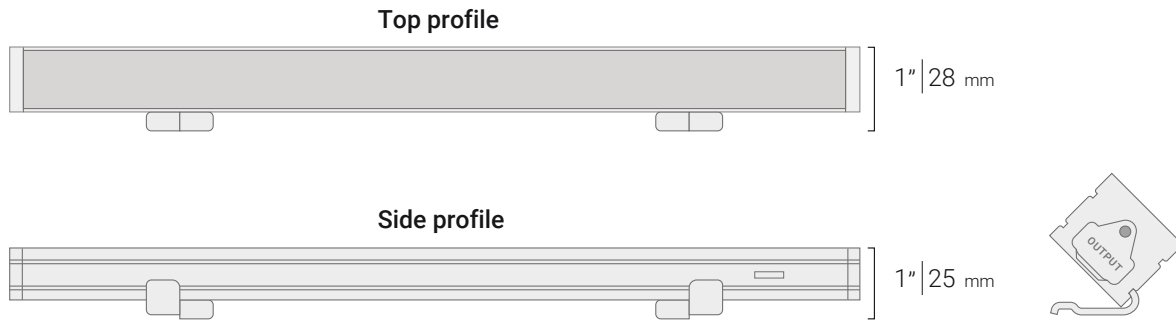

Specifications

Product SKU	Lumens / Fixture	Watts / Fixture	Luminous Efficacy (Lumens / Watt)	CRI	Gamut Score Rg (Color Sat.)	Relative Fidelity Score (RF)
END-MULTI-120V-01FT	Up to 1043	10W	Up to 104 lm/W	93	98	92
END-MULTI-120V-02FT	Up to 1960	20W	Up to 98 lm/W	94	98	92





Victory™

LED PUCK LIGHTS

Round, compact fixtures that emit a single point of bright light. Perfect for applications requiring accent or task lighting with great color rendering.

Victory™ LED Puck Lights



5-year
warranty



[> Visit Product Page](#)

Description

The Victory™ LED Puck Lights are round, compact fixtures that emit a single point of bright light. They are perfect for applications requiring accent or task lighting with great color rendering. Each puck light can be installed directly on a surface or recessed into cabinets or shelves.

There are two available color temperatures, Warm White (3000K) and Natural White (4000K), so you can match them to your favorite lighting fixtures. Thanks to their condensed illumination range, you can use them to highlight objects or decorations in an area or to enhance the overall look of a space by adding layers of light and focus points.

The Victory™ LED Puck Lights are fully dimmable and can be daisy chained up to 7 fixtures in a continuous run. They are low profile, very lightweight, and have a 5-year warranty.



Lumen Output:
260 lm/puck



Power:
3.2 Watts/puck



Color Temperatures:
30K, 40K



Daisy-Chain
up to 7 Pucks



Product Features

- High CRI up to 95
- Fully dimmable
- 120° beam angle
- Diameter: 2 1/2" (63 mm)
- Height: 1/2" (12 mm)
- Efficacy up to 65 lm/W
- 12V DC input voltage
- Ambient temperature: -4°F to 104°F (-20°C to 40°C)
- Able to chain up to 7 pucks

Dimensions

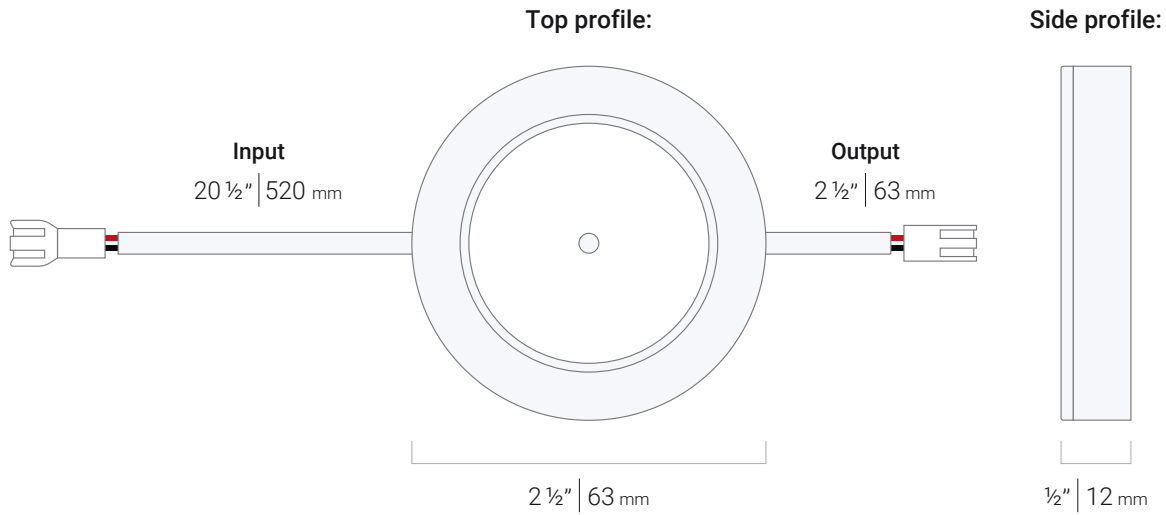

Specifications

Product SKU	Color (CCT)	Lumens / Fixture	Luminous Efficacy	CRI	Gamut Score Rg (Color Sat.)	Relative Fidelity Score (RF)	TLCI (Qa)
VIC-R-30K-S-12V	3000K	240	60 lm/W	95	103	93	93
VIC-R-40K-S-12V	4000K	260	65 lm/W	92	97	90	91



LED LIGHTING

Accessories



Aluminum Mounting Channels

Flexfire LEDs Mounting Channels are designed to ensure that your strip light lives a long life. By acting as a heat sink and providing a barrier from dust and debris, aluminum channels can extend the life of your strip light while also making maintenance simple. The channels are sold in one-meter pieces and can be mounted on practically any flat surface to give your project the finished look it deserves. We've packaged all components into a kit to include: channel, lens, mounting clips, end caps, and other accessories.

Benefits of Using Aluminum Channels:

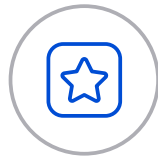

Stylish and Finished Look



Protection from Debris and Dust

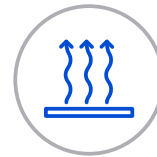







Excellent Heat Management



Longer Lifespan of Strip Light

Features

Channel Material	Aluminum
Color	Anodized aluminum finish
Mounting Clip Material	Stainless steel
End Cap Material	PVC
Lens Material	Polycarbonate
Field Cuttable	Yes
Warranty	6-years
Environmental	Suitable for dry/damp location use
Mounting Options	 Surface Mount  Angled Mount  Recessed Mount
Diffusion Covers	 Clear  Frosted  Opal

Name	Type	Included Accessories	Covers	Kit SKU	Mockup
Ion™	Heat Sink	No Additional Accessories	Not applicable	ION-CH-A-1M	
Gemini™	Surface Mount	2 Open End Caps 2 Closed End Caps 4 Mounting Clips	Clear Cover Frosted Cover Matte Cover	GEM-CH-A-CVR-C-1M GEM-CH-A-CVR-F-1M GEM-CH-A-CVR-M-1M	
Kepler™	Surface Mount	2 Open End Caps 2 Closed End Caps 4 Mounting Clips	Clear Cover Frosted Cover Matte Cover	KEP-CH-A-CVR-C-1M KEP-CH-A-CVR-F-1M KEP-CH-A-CVR-M-1M	
Laika™	Surface Mount	2 Open End Caps 2 Closed End Caps 4 Mounting Clips	Clear Cover Frosted Cover	LAI-CH-A-CVR-C-1M LAI-CH-A-CVR-F-1M	
Nova™	Surface Mount	2 Open End Caps 2 Closed End Caps 4 Mounting Clips	Clear Round Cover Matte Round Cover Clear Squared Cover Matte Squared Cover	NOV-CH-A-CVR-C-RD-1M NOV-CH-A-CVR-M-RD-1M NOV-CH-A-CVR-C-SQ-1M NOV-CH-A-CVR-M-SQ-1M	
Titan™	Surface Mount	2 Open End Caps 2 Closed End Caps 4 Mounting Clips 6 Channel Connectors	Clear Cover Frosted Cover Matte Cover	TTN-CH-A-CVR-C-1M TTN-CH-A-CVR-F-1M TTN-CH-A-CVR-M-1M	
Atlas™	Angled Mount	2 Open End Caps 2 Closed End Caps 4 Mounting Clips	Clear Cover Frosted Cover Matte Cover	ATL-CH-A-CVR-C-1M ATL-CH-A-CVR-F-1M ATL-CH-A-CVR-M-1M	
Calypso™	Recessed Mount	2 Open End Caps 2 Closed End Caps 4 Mounting Clips 6 Channel Connectors	Frosted Cover Matte Cover	CAL-CH-A-CVR-F-1M CAL-CH-A-CVR-M-1M	
Cassini™	Recessed Mount	2 Open End Caps 2 Closed End Caps 4 Mounting Clips	Clear Cover Frosted Cover Matte Cover	CAS-CH-A-CVR-C-1M CAS-CH-A-CVR-F-1M CAS-CH-A-CVR-M-1M	
Phoenix™	Recessed Mount	2 Open End Caps 2 Closed End Caps 6 Channel Connectors	Frosted Cover Matte Cover	PHO-CH-A-CVR-F-1M PHO-CH-A-CVR-M-1M	

Power Supplies

Zurik® Universal Dimmable Driver

The Zurik® Universal Dimmable Driver is the ultimate power supply for flawless dimming capabilities in any type of project. Offering a wide voltage input range, it is compatible with a large variety of AC wall dimmers and controllers. These drivers can even act as their own junction boxes and are IP66-rated for reliable, long-lasting use.



7-year
warranty



Dimming

TRIAC, MLV, ELV, 0-10V, 1-10V, Potentiometer, 10V PWM

Efficiency

Up to 92%

Power Factor

Up to 0.99

Cooling By

Free air convection

Voltage Tolerance

0.5 V

Voltage Regulation

0.5%

Dimming Range

0-100%

Deration Recommendation

80%

Minimum Load

10%

Frequency Range

47-63 Hz

THD (Typ)

<20%

Working Temperature

-40°F ~ 140°F (-40°C ~ 60°C)

Working Humidity

20 ~ 90%RH. Non Condensing

Temp Coefficient

0.03%/°C [32°F ~ 122°F
(0 ~ 50°C)]

Load Regulation

1%

Isolation Resistance

I/P-O/P:100MΩ/500VD-
C/25°C/70%RH

EMC Emission

FCC Part 15B

PWM Frequency

400Hz

Ingress Protection

IP66

Protection

Against Short Circuit,
Overloads, and Overheating

Overloading

≤120%

Overheating

212°F, 18°F (100°C, 10°C)
Driver shuts down when these
limits are exceeded

Short Circuit

Shuts down output voltage.
Re-powers on to recover after
the fault condition is removed.

Mean Well™ HLG Driver



7-year warranty



Mean Well™ power supplies are well-known in the industry for being a highly reliable and low-cost way to deliver power to your low voltage lighting systems. Built to last, the HLG series can be used with a variety of single-color output, color-changing, and tunable white LED lighting products. The Mean Well™ HLG series is IP65 rated, has an adjustable voltage and current option, and is protected against short-circuiting.



Features

- Electronic technology
- Up to 90% efficiency
- No knock-out holes
- Non-dimmable
- IP65 outdoor rated
- Automatic reset
- Type A: IP65, adjustable output voltage and constant current level
- Universal AC input / Full range (90 ~ 305VAC)
- Ambient temperature of -40°F to 158°F (-40°C to 70°C)
- Withstand 4kV surge, built-in active PFC function
- UL / CUL / TUV / PSE / CE certified
- Type "HL" LED drivers for use in Class I, Division 2 hazardous (Classified) location luminaries
- Suitable for LED street lighting, outdoor LED lighting, and general outdoor applications with high IP requirement
- No primary breaker (AC) or secondary breaker (DC)
- Output voltage and constant current ranges can be adjusted manually. Access the tuning ports by removing the rubber stopper.

Mean Well™ LPV Driver



2-year warranty



Mean Well™ power supplies are well known in the industry for being a highly reliable and low-cost way to deliver power to your low voltage lighting systems. Built to last, the LPV series can be used with a variety of single color output, color changing, and tunable white LED lighting products. The Mean Well™ LPV series is IP67 waterproof rated, and is protected against short-circuiting.



Features

- Electronic technology
- Load capacity up to 90%
- Withstand 300VAC surge input for 5 seconds (LPV/C-20/35/60/100)
- Automatic reset
- No knock-out holes
- Slim PFC plastic casing
- Ambient temperature of -30~+70°C
- Universal AC input / full range (up to 264 VAC)
- Non-dimmable; not compatible with AC in AC out dimmers such as Lutron, Legrand, Leviton dimmers
- IP67. For indoor or outdoor use without direct sunlight exposure
- Compatible with all Flexfire LED Strip Lights
- Recommended to be installed in a well ventilated area
- UL / CUL / TUV / PSE / CE certified
- No primary breaker (AC) or secondary breaker (DC)

Other Accessories

Flexfire LEDs offer you all the necessary components to help you achieve your project just like you envisioned. Contact us, and one of our dedicated project designers will help you create a list of product materials that include all of the components needed to achieve your lighting goals.

Controllers and Dimmers

Handheld remotes, wall dimmers, DMX controllers, and even smart home controllers compatible with Google Home or Amazon Alexa. You name it, we have the perfect solution for your project!



Handheld Remotes



Wall Dimmers



DMX Control
Systems



Smart Home
Controllers

Connectors



Solderless Connectors



Wet Location
Solderless Connectors

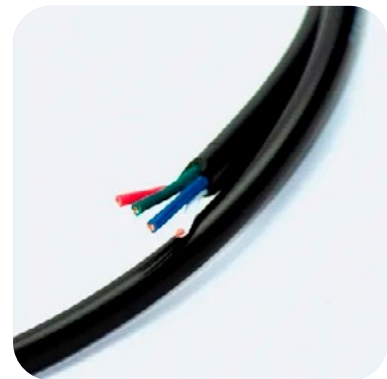

Extra Wire

Wire

Glossary

AC (Alternating Current) - This is the electricity that is used in most homes and commercial spaces. It's often referred to as line voltage and number differs from country to country. US line voltage is typically 90V-220V, whereas it often averages higher in Europe.

CCT - Not all white light appears the same. Correlated Color Temperature (CCT) defines the color appearance of a white light. CCT is defined in degrees Kelvin. Most white lights fall in a spectrum between 1800K and 6500K. When falling below 3000K, the light looks noticeably warmer like a candle. On the other end of the spectrum, the lights have a bluish tint and cooler tone when passing above 6500K. Some color temperatures will better suit your design than others. Choose complementary highlighting tones and look at example photos to find which you feel will look the best.

Chip Size - LED chips are all not all equal. What is the difference between 3528, 3014, and 5050 LEDs? The four digits represent the size of the chips in millimeters. For example, the 3528 chip is 3.5 mm x 2.8mm. Some chips are brighter than others and some have special uses and restrictions.

CQS - Color Quality Scale is an alternative to the unsaturated CRI measurement colors. There are 15 highly-saturated colors that are used to compare chromatic discrimination, human preference, and color rendering.

CRI (Color Rendering Index) - is the measurement of how colors look under a light source when compared with sunlight. Having information on the CRI of an LED strip light is important because you want to make sure that colors are being accurately represented by the light source.

DC (Direct Current) - Most LED strips on the market use low-voltage DC. An LED driver is required to step-down the AC voltage to a suitable level for the LED strips, which is normally 12V or 24V DC.

IP Rating - This is a rating system that defines the ability of a product to be able to work in different environments. IP is an acronym for "Ingress Protection". It is a measurement of the protection an item will have against solid objects (dust, sand, dirt, etc.) and liquids.

IP Rating

- *IP20* - No protection against water. Do NOT submerge IP20 LED lights. These are not waterproof.
- *IP65* - Water resistant. Protected against water jets from any angle.
Do NOT submerge IP65 LED lights. These are not waterproof.
- *IP67* - Water resistant plus. Protected against the events of temporary submersion (10 minutes).
Do NOT submerge IP67 LED lights for extended periods, these are not fully waterproof.
- *IP68* - Waterproof. Protected against the events of permanent submersion up to 3 meters.

LED - A Light Emitting Diode (LED) is a solid-state semiconductor device that converts electrical energy directly into light.

LED Binning - Simply put, binning is the process of grouping LEDs during production so that they match with LEDs of the same color sector. For consistent light and color output, we make sure that the LEDs are always ordered from the same bin.

LED Pitch - The distance between the individual chips on a strip. It is absolutely crucial to understand the importance that pitch plays in your project. The shorter the pitch, the more uniform the light tends to be and the less spotting tends to happen.

Lumens (lm) - A lumen is a measurement of lighting that represents the visible light output of a light source. We are all accustomed to using watts to measure the brightness of light, because of incandescent lighting. Today, we use lumens. Lumens are the most important variable when choosing your strip light. The higher the number, the brighter the light will be. Ensure that the strips you choose are bright enough for your application's intention.

Luminous Efficacy - This is calculated by measuring the lumen output and then dividing that number by watts. For example, a strip that has a lumen output of 300lm/ft and a wattage draw of 3w/ft has an efficiency of 100lm/W.

Solid-state Lighting - Lighting devices that do not contain moving parts or parts that can break, rupture, shatter, leak, or contaminate the environment. LEDs do not use electrical filaments or gasses to produce light.

TM-30 - The *Fidelity Index* measures how closely the observed light can render colors like the sun, using 99 color samples. The *Gamut Index* measures how saturated or desaturated colors are (aka how intense the colors are). The *Color Vector Graphic* measures which colors are saturated/desaturated and whether there is a hue shift in any of the 16 color bins.



FLEXFIRELEDS

If you are a contractor, electrician, OEM, distributor,
or designer, join our Partner Program and get:



Discounted pricing



FREE product samples



Expert lighting advice



Fast quoting



First access to NEW products

Toll Free Number:
1-844-353-9347



Local Number:
(925) 273-9080



www.flexfireleds.com



support@flexfireleds.com

Flexfire LEDs, Inc. 3554 Business Park Dr, Suite F. Costa Mesa, CA 92626