

Outdoor IP65 ColorBright™

RGB 150

LED Strip Light

Product Data Sheet

 Please read all instructions carefully before installation.

Description

The Outdoor (IP65) ColorBright™ RGB 150 LED Strip Lights are perfect for applications that require adjustable color settings, accent lighting, and added protection for projects in wet and damp locations. This LED strip light offers bold colors, millions of possibilities, intricate customization, easy installations, and more. With 150 color-changing LED chips over a 5-meter reel, this LED strip creates bold and beautiful colors with enough brightness to accentuate spaces with breathtaking lighting patterns. Its high-quality 5050 chip combines red, green and blue lights to create any color when paired with an RGB controller.

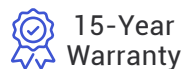

15-Year
Warranty



Product Features

Voltage	24V DC Input
LEDs/ft	9 LEDs/ft (30/meter)
Beam Angle	120° Beam Angle
Ambient Temp	-4°F to +113°F (-20°C to 45°C)
Strip Width	3/8" (10 mm)
LED Pitch	1/4" (33 mm)
Cutting Points	6 1/2" (165 mm)
Max Run Length in Series	49' 2" (15 m)
PCB	4 oz copper
LED Size	5050
Adhesive Type	3M 9495 tape (IP65)
Dimmable	Yes
Spool Size	16.4 ft (5 m)

Product Specifications

Product SKU	Watts / Foot (Meter)	Lumen / Foot (Meter)	Color Wavelength	Segment Lengths	Max Run Length in Series
IP65-CB-RGB150	2.2 W/ft (7.2 W/m)	66 lm/ft (216 lm/m)	R: 617-627 nm G: 515-525 nm B: 464-474 nm	6 1/2" (165 mm)	49 ft (15 m)

Ordering Code

IP Protection	Brand	Series	Voltage	Length
IP65 Wet Location	CB ColorBright™	RGB150	24V	16FT - 16ft Reel

Dimensions

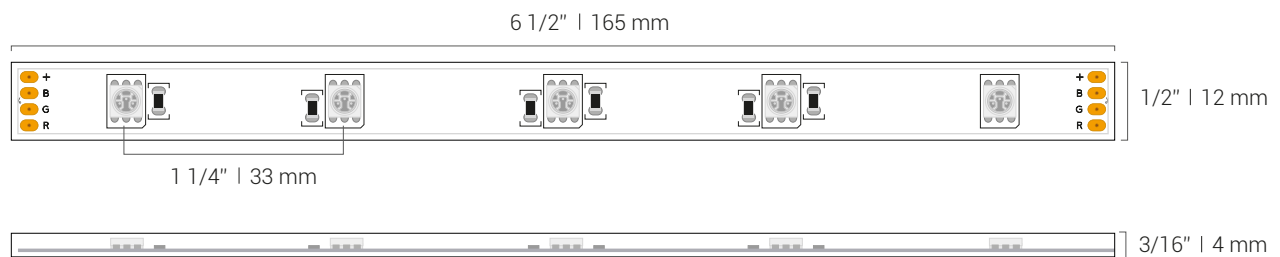

Included Accessories

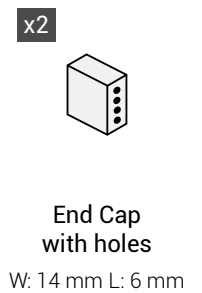
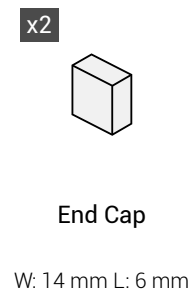
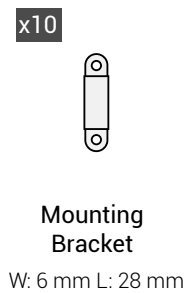
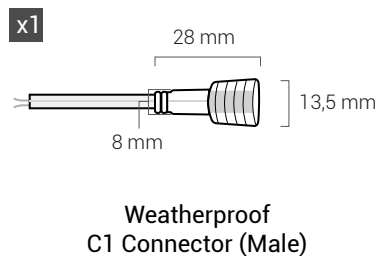
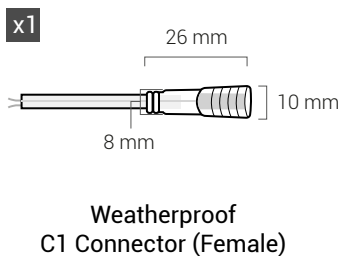

Dimming Options

PWM Dimming



DMX

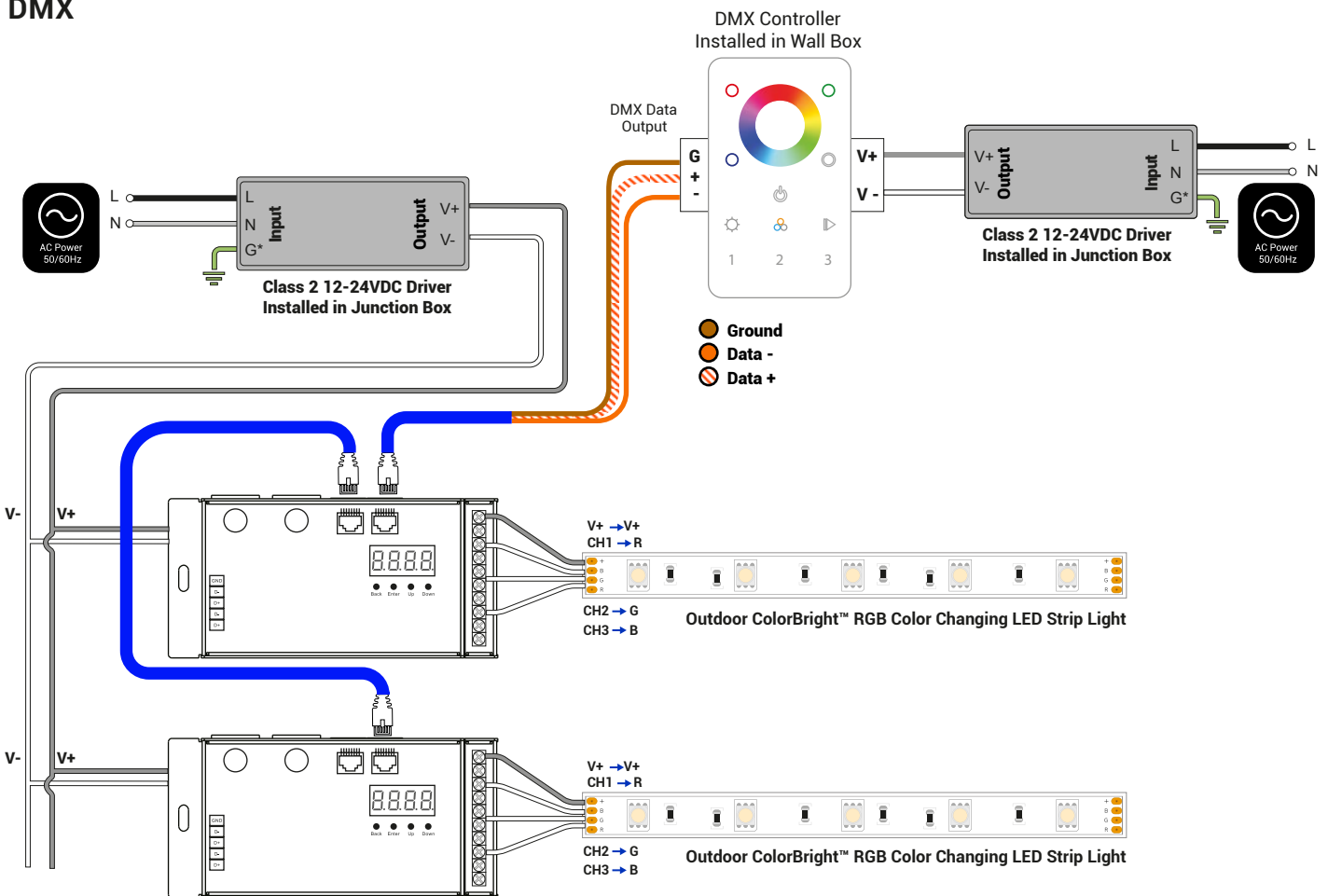

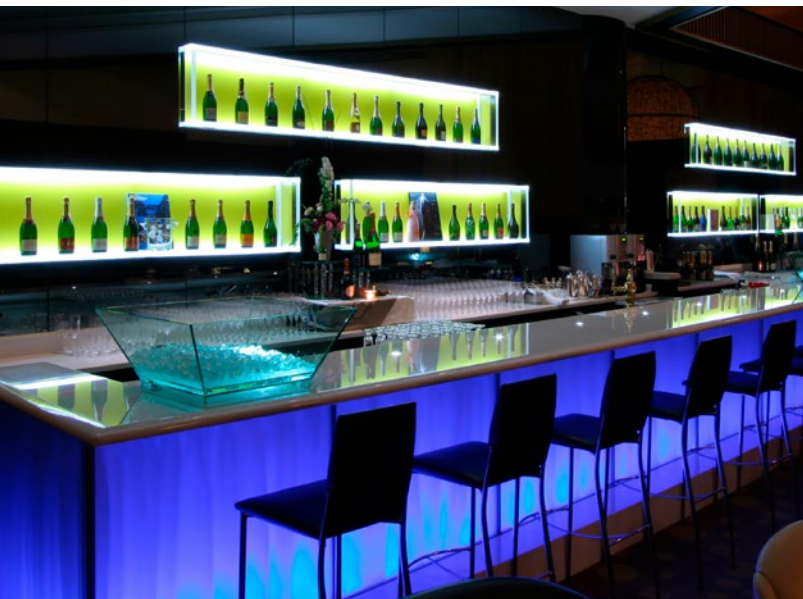

Compatible Drivers

Power Supply	LED Strip Length	Watts	Product SKU	Class 2	Diagram
Plug-In Power Supply	2 - 8 ft	24 W	24V-WMPS-1	X	
	9 - 21 ft	60 W	24V-DPS-2.5	X	
	22 - 34 ft	96 W	24V-DPS2-4	X	
	35 - 43 ft	120 W	24V-DPS2-5		
Mean Well™ HLG	2 - 16 ft	40 W	HLG-40H-24A	X	
	17 - 24 ft	60 W	HLG-60H-24A	X	
	25 - 39 ft	96 W	HLG-100H-24A	X	
	40 - 49 ft	120 W	HLG-120H-24A		
	50 - 75 ft	185 W	HLG-185H-24A		
	76 - 98 ft	240 W	HLG-240H-24A		
	99 - 130 ft	320 W	HLG-320H-24A		
131 - 245 ft	600 W	HLG-600H-24A			
Mean Well™ LPV	1 - 7 ft	20 W	LPV-20-24	X	
	8 - 13 ft	35 W	LPV-35-24	X	
	14 - 23 ft	60 W	LPV-60-24	X	

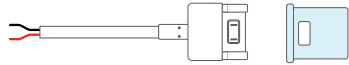
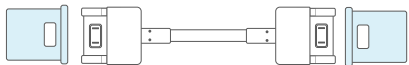

Strip Light Connectors

SKU	Description	Wire Gauge	Amperage** Limit	Diagram
IP65-GRIP-RGB-C1-10-40*	Outdoor IP65 Grip RGB Connector with 40" Bare Wire	22 AWG	5 Amps	
IP65-GRIP-RGB-C2-10-08*	Outdoor IP65 Grip RGB Jumper Connector with 8" Bare Wire			
IP65-GRIP-RGB-C3-10-0*	Outdoor IP65 Grip RGB Jumper Connector with No Wire	-		

*Calculate max length of LED strip to follow the solderless connector based on an amperage draw of 0.092 A/ft (0.3 A/m).

*Be sure no more than 5 amps is drawn after any solderless connector.

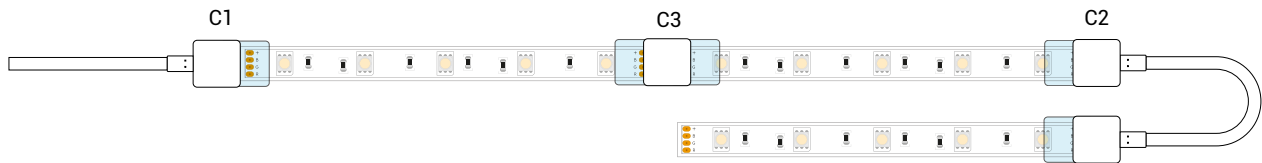

Strip Light Connectors Installation

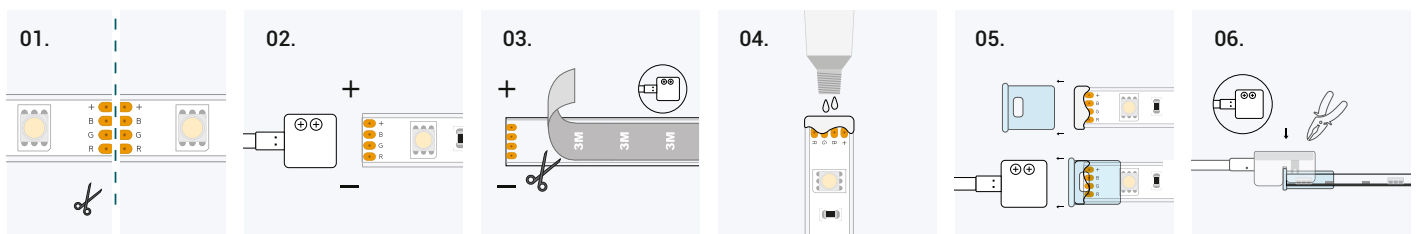

1. Cut the LED strip light and the silicone sleeve on the cutting point you want to install the connector.
2. Check the polarity.
3. Remove 2" of the adhesive tape and its backer from the back of the LED Strip light.
4. Apply Silicone sealant liberally inside of the silicone sleeve until ensuring it is completely sealed.
5. Slide the transparent case of your Outdoor IP65 Grip connector into the sleeve, until making sure that the strip is making proper contact.
6. Grab the white plastic part of your connector and push the metal contacts through the window of the transparent case. Adjust it with pliers until you hear a click, and then let the sealant cure according to its own instructions.

Compatible Aluminum Extrusions

Name	Type	Included Accessories	Covers	Kit SKU	Mockup
Ion™	Surface Mount	-	-	ION-CH-A-1M	
Atlas™	Surface Mount	2 Open End Caps 2 Closed End Caps 4 Metal Mounting Clips	Clear Cover, 1 m (3' 3/8") Frosted Cover, 1 m (3' 3/8") Matte Cover, 1 m (3' 3/8")	ATL-CH-A-CVR-C-1M ATL-CH-A-CVR-F-1M ATL-CH-A-CVR-M-1M	
Note: This extrusion only fits the RGB150 Series LED strip without connectors.					
Gemini™	Surface Mount	2 Open End Caps 2 Closed End Caps 4 Metal Mounting Clips	Clear Cover, 1 m (3' 3/8") Frosted Cover, 1 m (3' 3/8") Matte Cover 1, m (3' 3/8")	GEM-CH-A-CVR-C-1M GEM-CH-A-CVR-F-1M GEM-CH-A-CVR-M-1M	
Note: This extrusion only fits the RGB150 Series LED strip without connectors.					
Kepler™	Surface Mount	2 Open End Caps 2 Closed End Caps 4 Metal Mounting Clips	Clear Cover, 1 m (3' 3/8") Frosted Cover, 1 m (3' 3/8") Matte Cover 1, m (3' 3/8")	KEP-CH-A-CVR-C-1M KEP-CH-A-CVR-F-1M KEP-CH-A-CVR-M-1M	
Note: This extrusion only fits the RGB150 Series LED strip without connectors.					
Laika™	Surface Mount	2 Open End Caps 2 Closed End Caps 4 Metal Mounting Clips	Clear Cover, 1 m (3' 3/8") Frosted Cover, 1 m (3' 3/8") Matte Cover 1, m (3' 3/8")	LAI-CH-A-CVR-C-1M LAI-CH-A-CVR-F-1M	
Note: This extrusion only fits the RGB150 Series LED strip without connectors.					
Nova™	Surface Mount	2 Open End Caps 2 Closed End Caps 4 Metal Mounting Clips	Clear Round Cover, 1 m (3' 3/8") Clear Square, 1 m (3' 3/8") Matte Round Cover, 1 m (3' 3/8") Matte Square Cover, 1 m (3' 3/8")	NOV-CH-A-CVR-C-RD-1M NOV-CH-A-CVR-C-SQ-1M NOV-CH-A-CVR-M-RD-1M NOV-CH-A-CVR-M-SQ-1M	
Note: This extrusion only fits the RGB150 Series LED strip without connectors.					
Titan™	Surface Mount	2 Open End Caps 2 Closed End Caps 4 Metal Mounting Clips 6 Channel Connectors	Clear Cover, 1 m (3' 3/8") Frosted Cover, 1 m (3' 3/8") Matte Cover, 1 m (3' 3/8")	TTN-CH-A-CVR-C-1M TTN-CH-A-CVR-F-1M TTN-CH-A-CVR-M-1M	
Calypso™	Recessed	2 Open End Caps 2 Closed End Caps 4 Metal Mounting Clips	Clear Cover, 1 m (3' 3/8") Frosted Cover, 1 m (3' 3/8") Matte Cover, 1 m (3' 3/8")	CAL-CH-A-CVR-F-1M CAL-CH-A-CVR-M-1M	
Cassini™	Recessed	2 Open End Caps 2 Closed End Caps 4 Metal Mounting Clips	Clear Cover, 1 m (3' 3/8") Frosted Cover, 1 m (3' 3/8") Matte Cover, 1 m (3' 3/8")	CAS-CH-A-CVR-C-1M CAS-CH-A-CVR-F-1M CAS-CH-A-CVR-M-1M	
Note: This extrusion only fits the RGB150 Series LED strip without connectors.					
Phoenix™	Recessed	2 Open End Caps 2 Closed End Caps 6 Channel Connectors	Frosted Cover, 1 m (3' 3/8") Matte Cover, 1 m (3' 3/8")	PHO-CH-A-CVR-F-1M PHO-CH-A-CVR-M-1M	



Safety And Disclosures

1. Installation must be in accordance with local and national electrical code regulations.
2. To ensure safety and correct installation, our strips are intended to be installed by a qualified, licensed electrician.
3. Only install with a Class 2 DC Constant Voltage LED driver to meet UL requirements.
4. Do not install in environment where excessive heat may exist.
5. LED strip lights must be handled with care. Excessive handling, bending, and pressure may damage the product, voiding the warranty.
6. Do not install indoor LED tape light products in outdoor / wet location environments. Only use copper wiring. Use wires rated for at least 176°F (80°C) and certified for use with external connection of electrical equipment.
7. Each maximum run requires a dedicated power feed from the driver. Do not extend beyond the recommended maximum run length.
8. Make sure the appropriate gauge wire is installed between driver, LEDs, and any dimmers. When choosing wire, calculate voltage drop, maximum amperage rating, and the location ratings on the wire. Improper wire selection and installation could overheat wires, and cause fire.
9. Do not modify the product beyond instructions or warranty will be void.
10. We reserve the right to modify and improve the design of our fixtures without prior notice. Although we try our best to order the same colors every time, due to changes in technology and phosphors over time, we cannot guarantee to match existing installed fixtures for subsequent orders or replacements in regards to product appearance, CCT, or lumen output.

Warranty Information

Limited Warranty

This product has a 15 year limited warranty from the date of shipment. This warranty only includes the main product outlined in this specification sheet and does not include the additional accessories that are used as a reference. Complete warranty details for fixtures and additional accessories are available at <https://www.flexfireleds.com/warranties/> within the Policies section. For warranty related questions please contact the product support team at (support@flexfireleds.com).

Consumer's Acknowledgment

Flexfire LEDs, Inc. stands behind its products when they are used properly and according to our specifications. When you purchase our products, you are agreeing to the terms and conditions outlined in our warranty section. We try our best to make recommendations, but the burden of proper installation, design, and maintenance relies on the purchaser. This limited warranty does not include product failures that are the result of: Not using a voltage regulated power supply to connect the LED product or controls; Connecting LED products to the wrong output voltage; Improper connection of power supplies, LED products, or controls; Connecting LED products or controls directly to any AC power source if they are stated for DC only input; Connecting power supplies backwards to an AC power source; Products used in an inappropriate location or in environmental conditions (temperature, humidity, moisture, etc.) outside the normal specified range; Water damage to products not specifically sold as waterproof products; Electrical power surges and spikes; Damage from hail, flooding, tornado, fire, wind, earthquake, lightning, electrical storm, or any other natural disasters or "force majeure" incidences; Damage caused by a vehicle or other accident; Damage caused when transporting the item; Damage to any products that were modified by the user, used for purposes other than as intended or directed, or connected to LED systems or components not purchased from Flexfire LEDs; Products that have been subjected to misuse, mishandling, misapplication or accident. Products used in connection with any components, devices or systems other than those explicitly approved as compatible with Company's products and listed on Company's website. Excessive wear and tear and/or physical or accidental abuse, loss, or theft. Improper repairs or warranty services performed by someone other than Flexfire LEDs will void this warranty.

Contact Information



Toll Free Number:
1-844-353-9347



Local Number:
(925) 273-9080



info@flexfireleds.com



FLEXFIRELEDs

www.flexfireleds.com