



Outdoor IP65 ColorBright™
**RGB Digital Pixel
LED Strip Light**



Product Data Sheet



Pair it with our Juno™
Digital LED Controller to
Unlock Many Features:



**Multi-Directional
Light Effects**



**Variable
Speed Settings**



**Variable
Pixel Lengths**



**Hundreds
of Beautiful
Preset Modes**

Description

Our Outdoor (IP65) ColorBright™ RGB Digital Pixel LED Strip Light is a big step forward for our LED strip light offering. This strip incorporates a small integrated circuit every 6 LEDs creating a Pixel, for a total of 50 pixels in a 5-meter reel. The ability to control those 50 pixels individually gives way to beautiful, dynamic, breath-taking effects, which are perfect for commercial and entertainment environments.

You will have complete control over your Digital Pixel LED strip: when paired with a digital LED controller, you will be able to create chasing effects in countless patterns, while also being able to adjust the brightness, speed and direction of the pixels. The IP65 rating means that the LED strip lights are able to withstand jets and splashes of water from all sides. It cannot be submerged in water, but it will withstand the elements. We also recommend outdoor lights for use indoors in high splash areas or if you're looking for a strip that is easier to clean.

7 Year
Warranty



Product Features

Voltage	24V DC Input
Efficacy	Up to 29 lm/W
LEDs per Pixel	6 LEDs per Pixel
Pixels per Spool	50 Pixels per Spool
IC Protocol	WS2811
Beam Angle	120° Beam Angle
Ambient Temp	-4°F to +113°F (-20°C to 45°C)
Strip Width	1/2" (12 mm)
LED Pitch	7/16" (11 mm)
Cutting Points	4" (100 mm)
Maximum Run Length	32 ft (10 m)
PCB	3 oz copper
LED Size	5050
Adhesive Type	3M 9495LE tape (IP65)
Dimmable	Yes
Spool Size	16.4 ft (5 m)

Product Specifications

Product SKU	Watts/Foot	Watts/Meter	Lumens/Foot	Lumens/Meter	Luminous Efficacy Lumens/Watt
IP65-CB-DGTL-RGB-24V-16FT	3.65 W	12 W	107 lm/ft	350 lm/m	29 lm/w

Ordering Code

IP Protection	Brand	Series	Color	Voltage	Length
IP65 Wet Locations	CB ColorBright	DGTL Digital Pixel	RGB	24V	16FT 16ft Reel

Dimensions

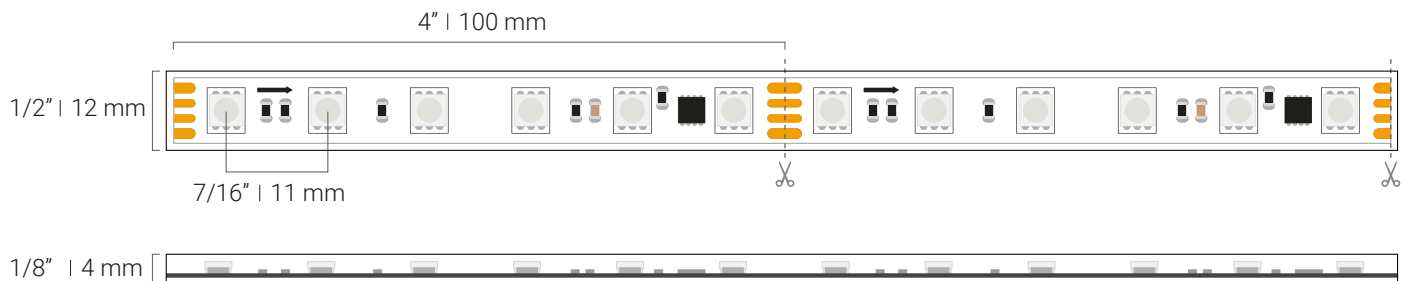

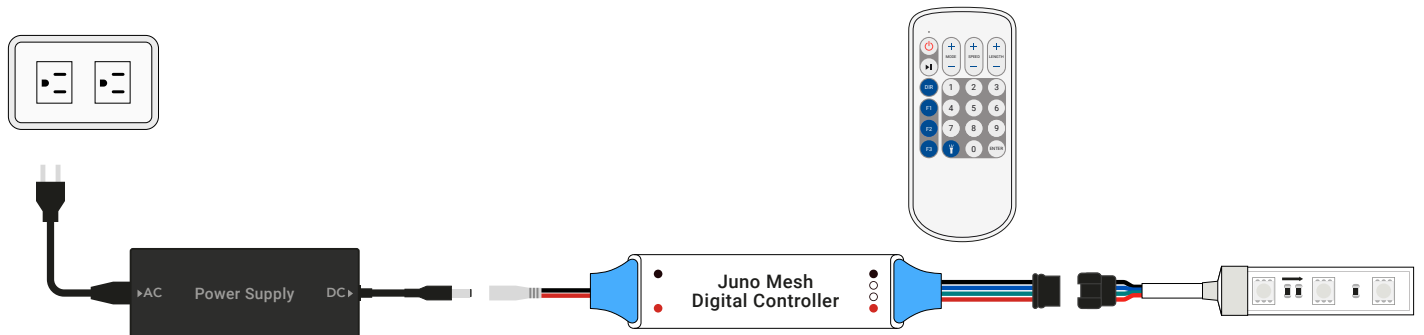

Controller Options

SPI Control

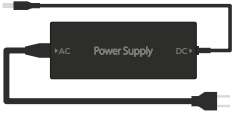

Compatible Drivers

Power Supply	LED Strip Length	Watts	Product SKU	Diagram
Plug-In Power Supply	1 - 5 ft	24 W	24V-WMPS-1	
	6 - 13 ft	60 W	24V-DPS-2.5	
	14 - 21 ft	96 W	24V-DPS-4	
	22 - 26 ft	120 W	24V-DPS-5	
Mean Well™ HLG	2 - 9 ft	40 W	HLG-40H-24A	
	10 - 14 ft	60 W	HLG-60H-24A	
	15 - 24 ft	96 W	HLG-100H-24A	
	25 - 29 ft	120 W	HLG-120H-24A	
	30 - 45 ft	185 W	HLG-185H-24A	
	46 - 59 ft	240 W	HLG-240H-24A	
	60 - 78 ft	320 W	HLG-320H-24A	
	79 - 147 ft	600 W	HLG-600H-24A	
Mean Well™ LPV	1 - 4 ft	20 W	LPV-20-24	
	5 - 8 ft	36 W	LPV-35-24	
	9 - 14 ft	60 W	LPV-60-24	

Special Installation Instructions

01 

When working with our Outdoor (IP65) ColorBright™ RGB Digital Pixel LED Strip Light please make all necessary connections before applying power to the LED strip. Do not cut the strips or make/remove connections while power is applied.

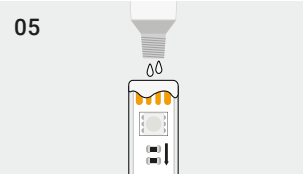
05 

Apply Silicone sealant liberally inside of the silicone sleeve until ensuring it is completely sealed.

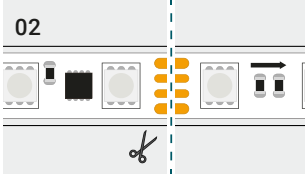
02 

Cut the LED strip light and the silicone sleeve on the cutting point you want to install the connector.

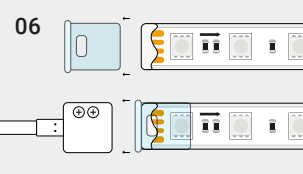
06 

Slide the transparent case of your Outdoor IP65 Grip connector into the sleeve, until making sure that the strip is making proper contact.

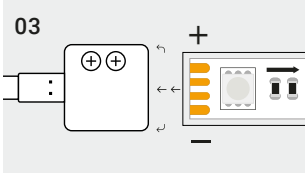
03 

Make sure to use the same color wire for the same channels on the strip. Double check that you are using the same color for the positive (+) channel, and the same colors for the GROUND (GND) and DATA (DI or D0, depending on the end of the strip) channels.

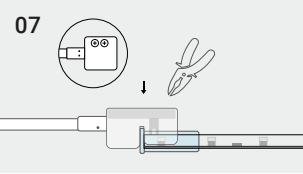
07 

Grab the white plastic part of your connector and push the metal contacts through the window of the transparent case. Adjust it with pliers until you hear a click, and then let the sealant cure according to its own instructions.

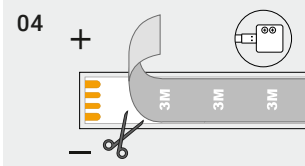
04 

Check the polarity and remove 2" of the adhesive tape and its backer from the back of the LED Strip light.

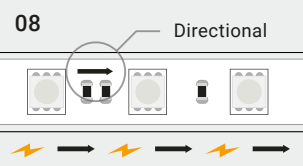
08 

Directional

After making all connections, you will be ready to apply power. Please keep in mind that this LED strip light is directional, so the data can only flow from one direction. There are arrows printed on the PCB indicating the correct direction.

Strip Light Connectors

SKU	Description	Wire Gauge	Amperage** Limit	Diagram
IP65-GRIP-RGB-C1-10-40	Outdoor IP65 RGB Grip Connector with 40" Bare Wire	22 AWG	5 Amps	
IP65-GRIP-RGB-C2-10-08	Outdoor IP65 RGB Jumper Grip Connector with 8" Bare Wire	22 AWG		
IP65-GRIP-RGB-C3-10-0	Outdoor IP65 RGB Jumper Grip Connector with No Wire	-		

* Calculate max length of LED strip to follow the solderless connector based on an amperage draw of 0.14 A/ft (0.45 A/m) at 24 volts.

** Be sure no more than 5 amps is drawn after any solderless connector.

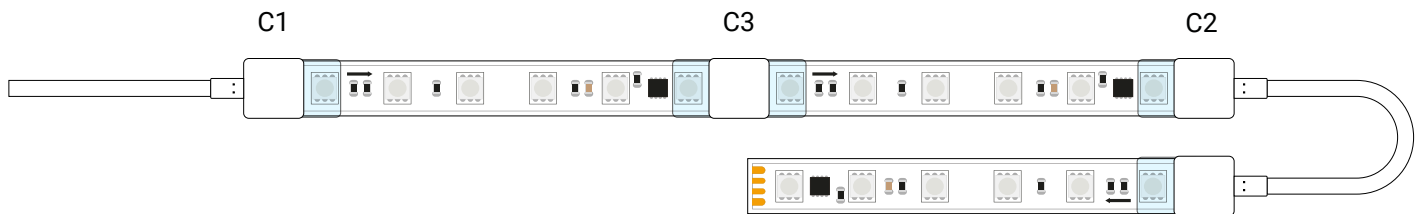





Compatible Aluminum Extrusions

Flexfire LEDs Mounting Channel Kits

Name	Type	Included Accessories	Covers	Kit SKU	Mockup
Laika™	Surface	2 Open End Caps	Clear Cover, 1 m (3' 3/8")	SKU: LAI-CH-A-CVR-C-1M	
	Mount	2 Closed End Caps 4 Metal Mounting Clips	Frosted Cover, 1 m (3' 3/8")	SKU: LAI-CH-A-CVR-F-1M	
Note: This extrusion only fits the ColorBright™ IP65 RGB Digital Pixel LED strip without connectors.					
Gemini™	Surface	2 Open End Caps	Clear Cover, 1 m (3' 3/8")	SKU: GEM-CH-A-CVR-C-1M	
	Mount	2 Closed End Caps 4 Metal Mounting Clips	Frosted Cover, 1 m (3' 3/8") Matte Cover, 1 m (3' 3/8")	SKU: GEM-CH-A-CVR-F-1M SKU: GEM-CH-A-CVR-M-1M	
Cassini™	Recessed	2 Open End Caps	Clear Cover, 1 m (3' 3/8")	SKU: CAS-CH-A-CVR-C-1M	
		2 Closed End Caps 4 Metal Mounting Clips	Frosted Cover, 1 m (3' 3/8") Matte Cover, 1 m (3' 3/8")	SKU: CAS-CH-A-CVR-F-1M SKU: CAS-CH-A-CVR-M-1M	
Nova™	Surface	2 Open End Caps	Clear Round Cover, 1 m (3' 3/8")	SKU: NOV-CH-A-CVR-C-RD-1M	
	Mount	2 Closed End Caps 4 Metal Mounting Clips	Clear Square, 1 m (3' 3/8") Matte Round Cover, 1 m (3' 3/8") Matte Square Cover, 1 m (3' 3/8")	SKU: NOV-CH-A-CVR-C-SQ-1M SKU: NOV-CH-A-CVR-M-RD-1M SKU: NOV-CH-A-CVR-M-SQ-1M	
Kepler™	Surface	2 Open End Caps	Clear Cover, 1 m (3' 3/8")	KEP-CH-A-CVR-C-1M	
	Mount	2 Closed End Caps 4 Metal Mounting Clips	Frosted Cover, 1 m (3' 3/8") Matte Cover, 1 m (3' 3/8")	KEP-CH-A-CVR-F-1M KEP-CH-A-CVR-M-1M	
Note: This extrusion only fits the ColorBright™ IP65 RGB Digital Pixel LED strip without connectors.					
Atlas™	Surface	2 Open End Caps	Clear Cover, 1 m (3' 3/8")	ATL-CH-A-CVR-C-1M	
	Mount	2 Closed End Caps 4 Metal Mounting Clips	Frosted Cover, 1 m (3' 3/8") Matte Cover, 1 m (3' 3/8")	ATL-CH-A-CVR-F-1M ATL-CH-A-CVR-M-1M	
Titan™	Surface	2 Open End Caps	Clear Cover, 1 m (3' 3/8")	TTN-CH-A-CVR-C-1M	
	Mount	2 Closed End Caps 4 Metal Mounting Clips 6 Channel Connectors	Frosted Cover, 1 m (3' 3/8") Matte Cover, 1 m (3' 3/8")	TTN-CH-A-CVR-F-1M TTN-CH-A-CVR-M-1M	
Calypso™	Recessed	2 Open End Caps	Frosted Cover, 1 m (3' 3/8")	CAL-CH-A-CVR-F-1M	
		2 Closed End Caps 4 Metal Mounting Clips 6 Channel Connectors	Matte Cover, 1 m (3' 3/8")	CAL-CH-A-CVR-M-1M	
Ion™	Surface	-	-	SKU: ION-CH-A-1M	
	Mount	-	-	-	

Compatible Aluminum Extrusions

Name	Covers	End Caps	Mounting Accessories	Mockup
KLUS TAMI Anodized Extrusion with Translucent Cover SKU: KL-B5390ANODA-1m		<ul style="list-style-type: none"> · KLUS ECO TAMI SKU: KL-20051 	<ul style="list-style-type: none"> · KLUS Stainless Steel Mounting Bracket SKU: KL-24190 	
Note: This extrusion only fits the ColorBright™ IP65 RGB Digital Pixel LED strip without connectors.				
KLUS GIZA Anodized Extrusion SKU: KL-B5556ANODA-1m	<ul style="list-style-type: none"> · KLUS - HS 22 Clear Cover SKU: KL-17022-1m · KLUS LIGER 22 Frosted Cover SKU: KL-17032-1m 	<ul style="list-style-type: none"> · KLUS GIZA End Cap SKU: KL-24007 	<ul style="list-style-type: none"> · KLUS GP Surface Spring SKU: KL-00293 · KLUS Mounting Bracket SKU: KL-24143 	
Note: This extrusion only fits the ColorBright™ IP65 RGB Digital Pixel LED strip without connectors.				
KLUS LIPOD Anodized Extrusion SKU: KL-B5554ANODA-1m	<ul style="list-style-type: none"> · KLUS LIGER 22 Frosted Cover SKU: KL-17032-1m 	<ul style="list-style-type: none"> · KLUS LIPOD-MET SKU: KL-24051 	<ul style="list-style-type: none"> · KLUS Mounting Bracket SKU: KL-24143 	
KLUS KOPRO Anodized Extrusion SKU: KL-B6367ANODA-1m	<ul style="list-style-type: none"> · KLUS KOPRO L Cover SKU: KL-17092-1m 	<ul style="list-style-type: none"> · KLUS KOPRO L SKU: KL-24116 	<ul style="list-style-type: none"> · KLUS GP Surface Spring SKU: KL-00293 	
KLUS SILER Anodized Extrusion SKU: KL-B9325ANODA-1m	<ul style="list-style-type: none"> · KLUS SILER Frosted Cover SKU: KL-17039-1m 	<ul style="list-style-type: none"> · KLUS SILER SKU: KL-24236 	<ul style="list-style-type: none"> · KLUS 45-STN Mounting Bracket SKU: KL-24144 	
Note: This extrusion only fits the ColorBright™ IP65 RGB Digital Pixel LED strip without connectors.				

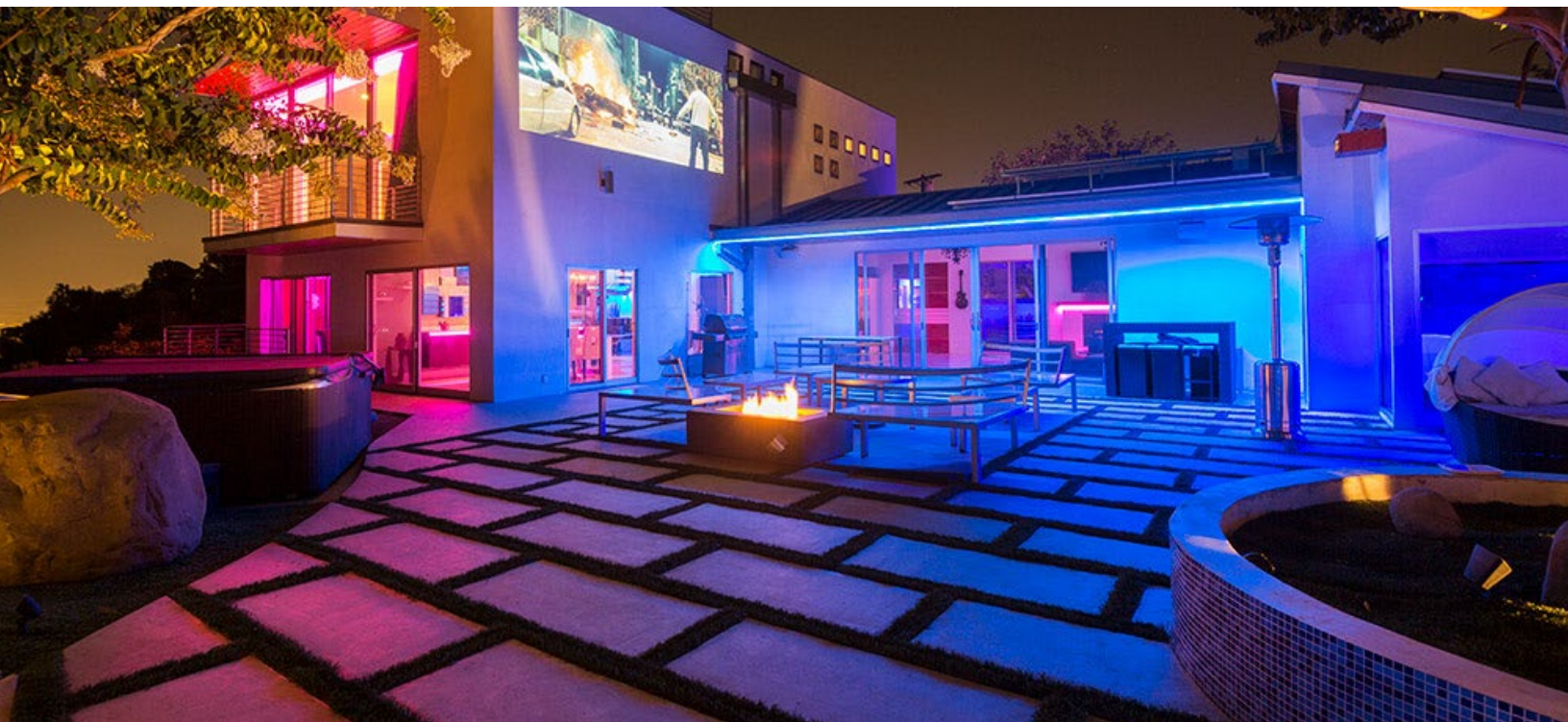

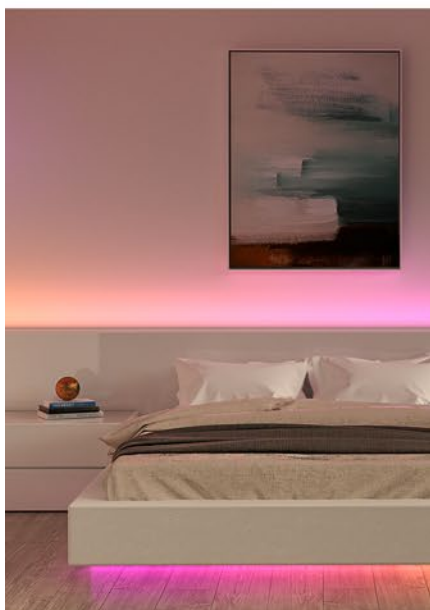

Safety And Disclosures

1. Installation must be in accordance with local and national electrical code regulations.
2. To ensure safety and correct installation, our strips are intended to be installed by a qualified, licensed electrician.
3. Only install with a Class 2 DC Constant Voltage LED driver to meet UL requirements.
4. Do not install in an environment where excessive heat may exist.
5. LED strip lights must be handled with care. Excessive handling, bending, and pressure may damage the product, voiding the warranty.
6. Do not install indoor LED tape light products in outdoor / wet location environments. Only use copper wiring. Use wires rated for at least 176°F (80°C) and certified for use with external connection of electrical equipment.
7. Each maximum run requires a dedicated power feed from the driver. Do not extend beyond the recommended maximum run length.
8. Make sure the appropriate gauge wire is installed between the driver, LEDs, and any dimmers. When choosing wire, calculate voltage drop, maximum amperage rating, and the location ratings on the wire. Improper wire selection and installation could overheat wires, and cause fire.
9. Do not modify the product beyond instructions or warranty will be void.
10. We reserve the right to modify and improve the design of our fixtures without prior notice. Although we try our best to order the same colors every time, due to changes in technology and phosphors over time, we cannot guarantee to match existing installed fixtures for subsequent orders or replacements in regards to product appearance, CCT, or lumen output.

Warranty Information

Limited Warranty

This product has a 7 year limited warranty from the date of shipment. This warranty only includes the main product outlined in this specification sheet and does not include the additional accessories that are used as a reference. Complete warranty details for fixtures and additional accessories are available at <https://www.flexfireleds.com/warranties/> within the Policies section. For warranty related questions please contact the product support team at (support@flexfireleds.com).

Consumer's Acknowledgment

Flexfire LEDs, Inc. stands behind its products when they are used properly and according to our specifications. When you purchase our products, you are agreeing to the terms and conditions outlined in our warranty section. We try our best to make recommendations, but the burden of proper installation, design, and maintenance relies on the purchaser.

This limited warranty does not include product failures that are the result of: Not using a voltage regulated power supply to connect the LED product or controls; Connecting LED products to the wrong output voltage; Improper connection of power supplies, LED products, or controls; Connecting LED products or controls directly to any AC power source if they are stated for DC only input; Connecting power supplies backwards to an AC power source; Products used in an inappropriate location or in environmental conditions (temperature, humidity, moisture, etc.) outside the normal specified range; Water damage to products not specifically sold as waterproof products; Electrical power surges and spikes; Damage from hail, flooding, tornado, fire, wind, earthquake, lightning, electrical storm, or any other natural disasters or "force majeure" incidences; Damage caused by a vehicle or other accident; Damage caused when transporting the item; Damage to any products that were modified by the user, used for purposes other than as intended or directed, or connected to LED systems or components not purchased from Flexfire LEDs; Products that have been subjected to misuse, mishandling, misapplication or accident. Products used in connection with any components, devices or systems other than those explicitly approved as compatible with Company's products and listed on Company's website. Excessive wear and tear and/or physical or accidental abuse, loss, or theft. Improper repairs or warranty services performed by someone other than Flexfire LEDs will void this warranty.



Contact Information



Toll Free Number:
1-844-353-9347



Local Number:
(925) 273-9080



info@flexfireleds.com



FLEXFIRELEDs

www.flexfireleds.com