

COLOR CHANGING + WHITE MULTI-ZONE LED Remote Control & Receiver

INTRODUCTION

The Multi-Zone remote control and receiver combo for RGBW LED strip lights uses the most advanced RF wireless transmission technology. The system consists of two parts: the handheld remote control and the in-line receiver. Featuring a 2 in 1 (Sync and Zone) programmable remote control, it allows you to simultaneously control unlimited receivers or independently control 8 zones also with unlimited receivers. Quickly alter the brightness, colors of the LED strip and browse through the 10 preset modes. In addition, it includes a wall mount to easily mount the remote control on a nearby wall. The unit is compatible with any Flexfire LEDs ColorBright RGB+W LED strip.

SAFETY AND WARNINGS

- Install in accordance with the National Electric Code, and local regulations.
- This product should be installed and serviced by a qualified electrician.
- Do not connect directly to high voltage 120V AC power.
- This product is rated for indoor installation and is not protected against moisture.
- Proper heat dissipation will prolong the working lifespan of this product. Install in a well ventilated area.
- Only install compatible LED drivers and fixtures. Contact Technical Support or visit the product page for compatible accessories.
- Ensure applicable wire is installed between driver, fixture, and any controls in between. When choosing wire, factor in voltage drop, amperage rating, and type (in-wall rated, wet location rated, etc). Inadequate wire installation could overheat wires and cause fire.
- Utilize the wiring diagrams in this installation guide for basic setups.

REMOTE CONTROL

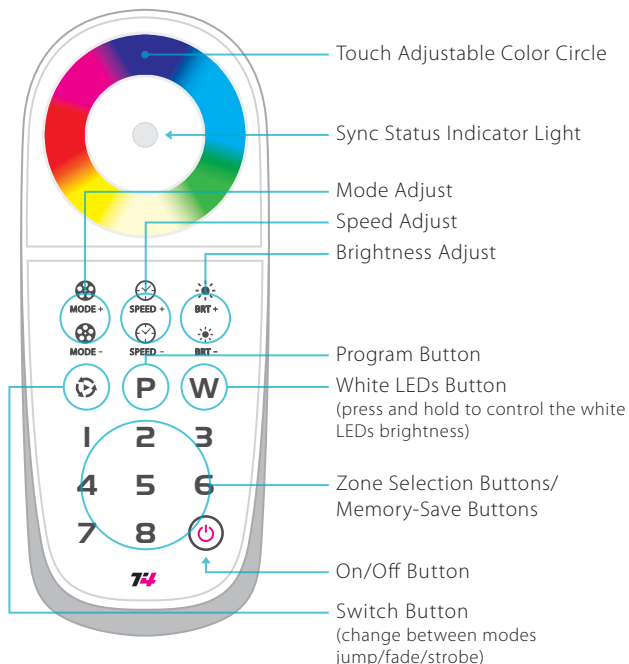

Details

SKU:	RGBW-MZ-CTRL
Working Voltage:	5V (Built-in lithium battery)
Working Frequency:	2.4GHz
Max. Signal Range:	98ft (30m)
Working Temp:	-22°F ~ 131°F (-30°C ~ 55°C)
Dimensions:	H: 5 3/4" (146mm) W: 2 1/4" (56mm) D: 7/8" (22mm)*
Weight:	7oz (200g)
Warranty:	5 years

*Comes with a wall mount for easy storage

RECEIVER

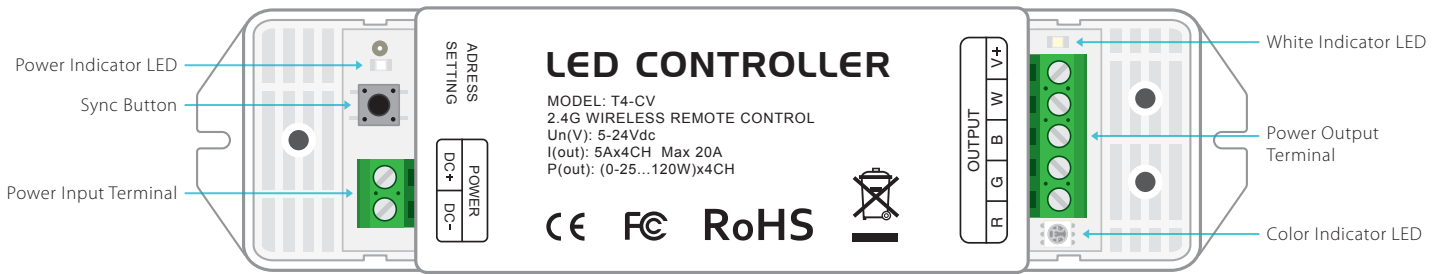

Details

SKU:	RGBW-MZ-RCVR	Working Temp:	-22°F ~ 131°F (-30°C ~ 55°C)
Input Voltage:	5V-24V DC	Dimensions:	H: 6 15/16" (176mm) W: 1 3/4" (45mm) D: 1 3/16" (30mm)
Max Current Load:	5A x 4CH	Weight:	5.3oz (150g)
Max Output Power:	12V: 180W, 24V: 360W	Warranty:	5 years

YOU'LL NEED

<p>Small flat-head screwdriver (4mm)</p>	<p>Wire strippers or scissors</p>	<p>5-wire stranded low voltage wire for extended runs (consult an electrician for wire gauge advice)</p>
<p>Low voltage non-dimmable power supply</p>	<p>ColorBright™ RGBW LED strip</p>	<p>Remote control & receiver</p>

INSTALLATION

Always pre-test your LED setup prior to permanent installation. This will ensure all components work correctly. Be sure to check the amperage rating of the LED strip you've purchased so the receiver isn't overloaded (max 5 amps per channel). Turn off the main AC breaker for the line you'll be using before installing your low voltage power supply. If you experience any issues at all with your test set up, please be sure to contact us at After Sales Support.

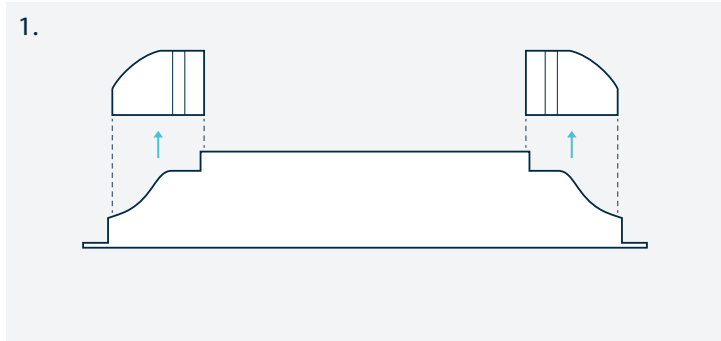

Unscrew the left and right cover plates on the receiver. This will expose the Input and Output Power Terminals.

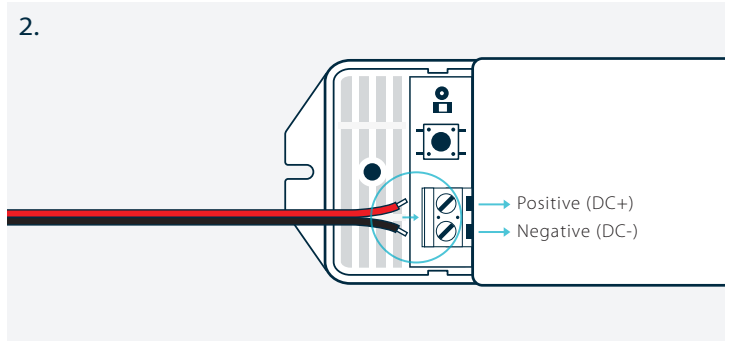

Loosen the Power DC+ and DC- screws and insert the black wire from your low voltage non-dimmable power supply in the DC- channel and secure the screw. Then insert the red wire from the power supply in the DC+ channel and secure the screw.

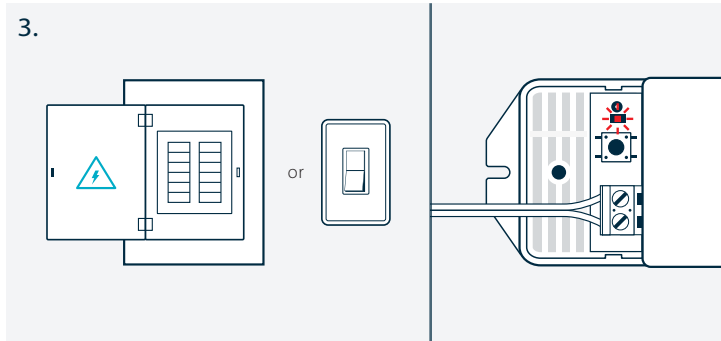

Turn the main breaker for the AC line back on to power your non-dimmable power supply. The red Power Indicator LED will turn on.

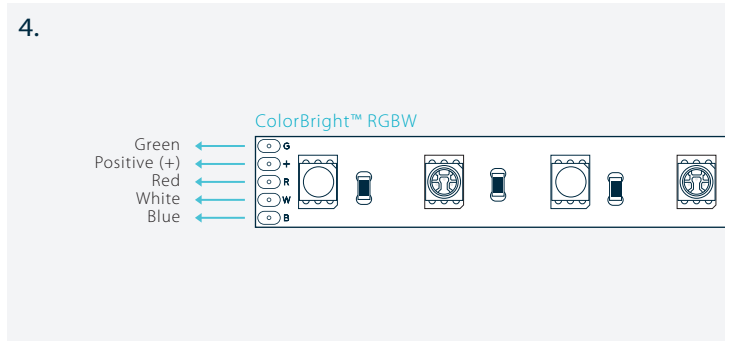

Look at your LED strip carefully and identify the positive (+), R, G, B and W channels.

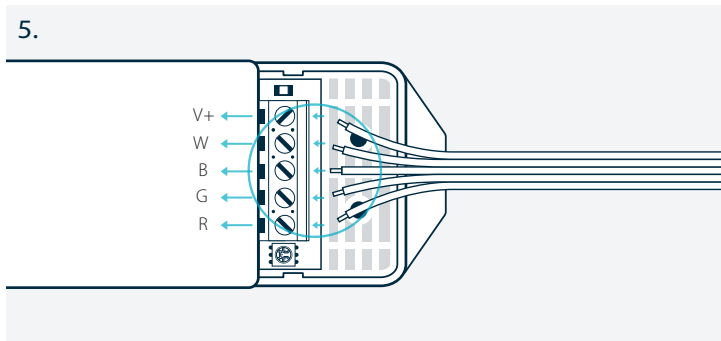

Loosen the Output V+, R, G, B and W screws. Then connect the + wire from the LED strip to the V+ port in the receiver and secure the screw. Do the same to match the rest of the wires to their respective ports R, G, B, and W.

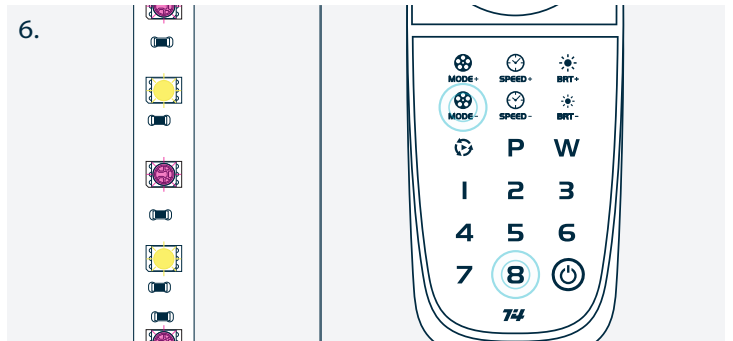

Press the Power Button on the remote control, the LED strip will turn on. Then hold Mode- and 8 simultaneously for about 2 seconds to go into the Zone Control Program, this will let you sync unlimited receivers into 8 independent zones. **Pressing Mode+ and 8 will let you control unlimited receivers simultaneously with the Sync Control Program.

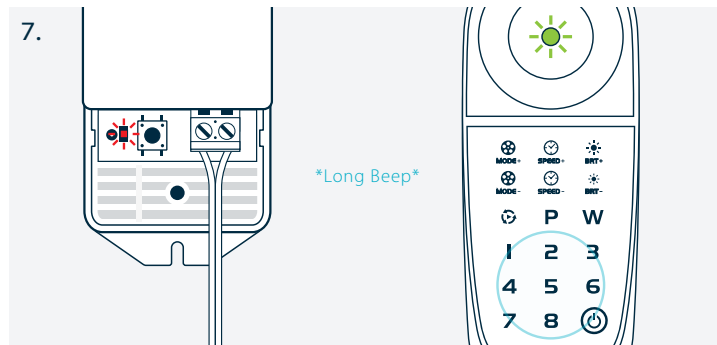

Press the black Sync Button on the receiver once and the the Power Indicator LED will remain static, then quickly press and hold the zone you wish to assign that receiver to (1-8) on the remote. The Power Indicator LED will flash faster, you'll hear a long beep and the Sync Status Indicator Light will flash 3 times. The remote is synced. You can assign unlimited receivers to a single zone (1-8) by syncing as many receivers as you need to the same number.

ADDITIONAL FEATURES

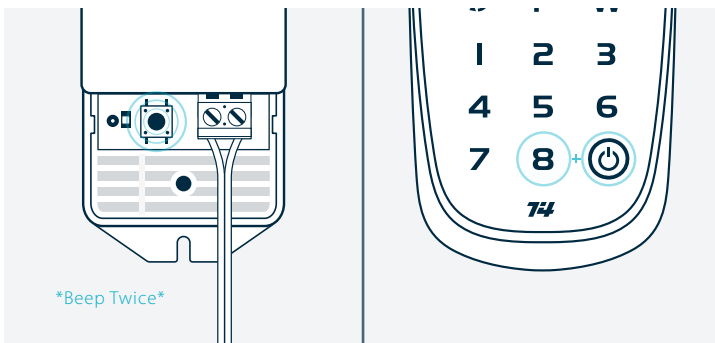

Reset the Receiver and the Remote

Press and hold the black Sync Button on the receiver until you hear it beep twice (about 10 seconds). The synced remote will be forgotten. In case the remote acts abnormally, simply long press 8 + Power Button simultaneously until the remote turns off (about 3 seconds). The remote is reset, you can turn it back on after about a minute.

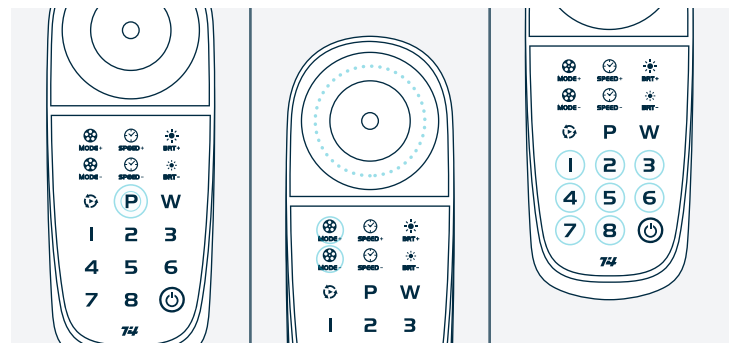

Programming

In either Sync Control or Zone Control Program, press and hold the Programming Button until you hear a beep (about 3 seconds). Use the Mode+, Mode- buttons or Touch Color Circle, to select a color and save it to a zone by pressing a number 1-8 (you can save up to 8 colors). You can save 1 custom color or mode in zone control. (refer to the preset modes table to see the preset modes you can save).

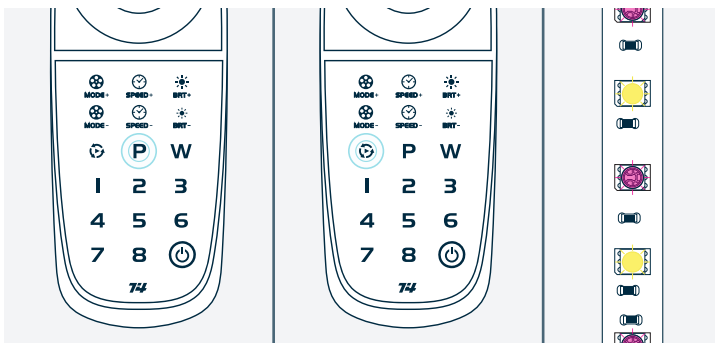

Switch saved colors

Short press the Programming Button to exit color selection. Then use the Switch Button to determine how the colors will transition (jump/fade/strobe).



Save your custom setting

In the Sync Control Program press and hold any number (1-8) to save the custom scene. In the Zone Control Program short press the Programming Button to play back the scene.

INSTALLATION

No.	Press Mode + or Mode - to scroll through colors	Press  button to switch the 3 types		
		Jumping	Fade	Strobe
1	Black	-	-	-
2	Red	Static Red	Red fade out and fade in	Red strobe
3	Green	Static Green	Green fade out and fade in	Green strobe
4	Blue	Static Blue	Blue fade out and fade in	Blue strobe
5	Yellow	Static Yellow	Yellow fade out and fade in	Yellow strobe
6	Purple	Static Purple	Purple fade out and fade in	Purple strobe
7	Cyan	Static Cyan	Cyan fade out and fade in	Cyan strobe
8	White	Static White	White fade out and fade in	White strobe
9	Red, Green, Blue	RGB Jumping	RGB color fade	RGB Phase
10	Red, Green, Blue, Yellow, Purple, Cyan, White	7 Colors Jumping	Full-color fade	7 colors strobe

REMOTE CONTROL CHARGING

1. To charge the remote control, connect the mini USB cable to the remote and the opposite end of the cable to a regular USB port (computer or USB charger).
2. The LED indicator on the remote will flash to show that the remote is charging. If the remote is turned off, however, the indicator will not flash.
3. When the battery is fully charged, the LED light will remain static.
4. The rechargeable battery in the remote does not have a "memory" so no special care is needed when charging.
5. When not plugged in with the charge cable, the LED indicator on the remote will flash to show that the battery is low and will need to be charged soon.
6. Do not allow the battery to become fully discharged. When the remote tells you the battery is low, it is a good idea to charge it.
7. When storing the remote for long periods of time, it's a good idea to leave it fully charged. Be sure to fully charge the battery at least every 3 months to extend its lifespan.

WIRING DIAGRAM

1. Single Receiver wiring

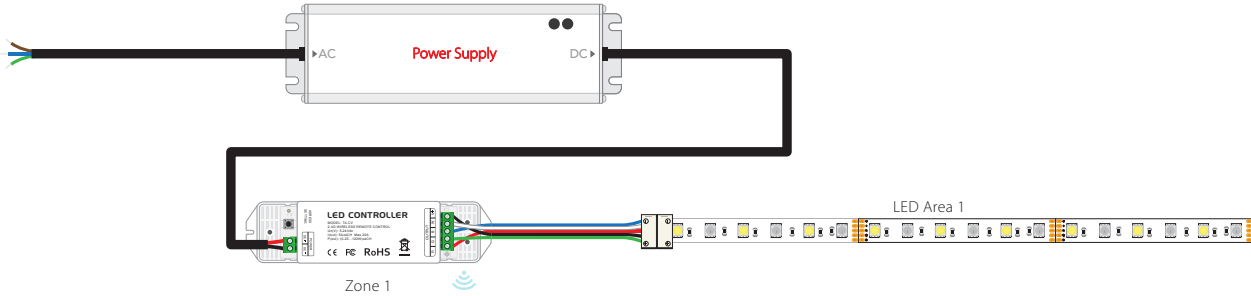

2. Multiple Receiver wiring

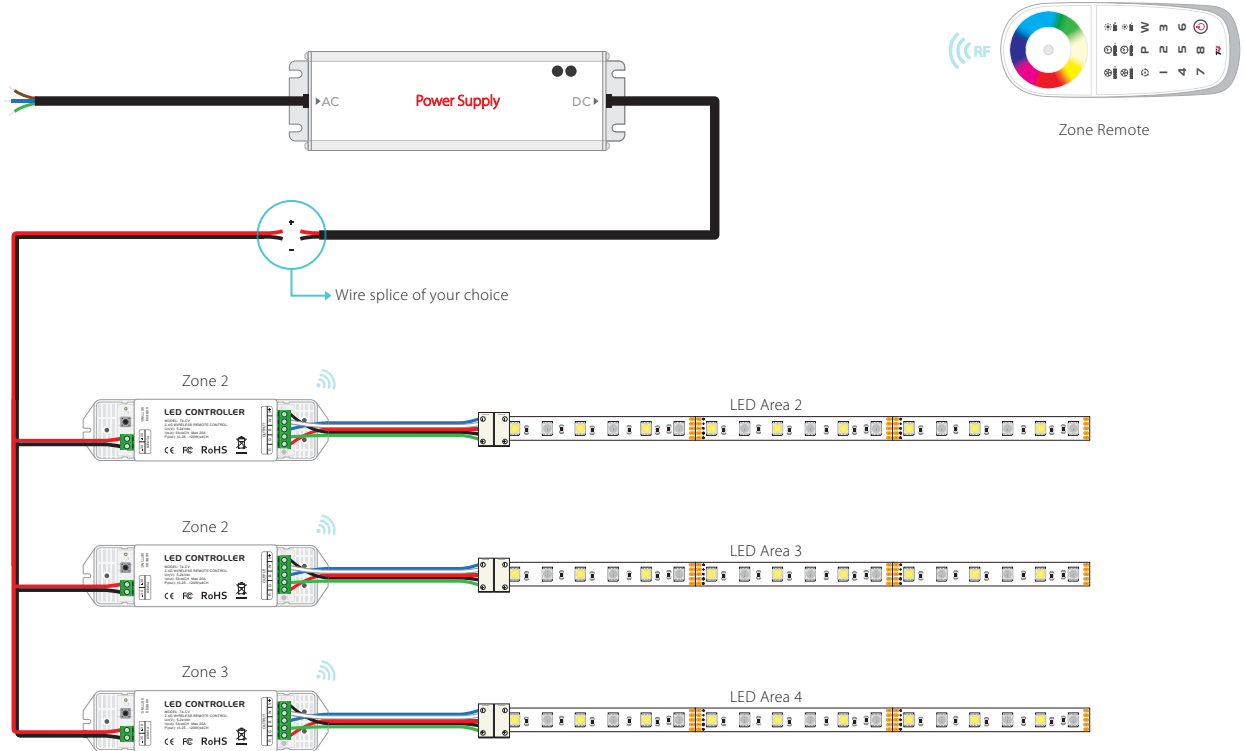

TROUBLESHOOTING

- If your lights are not turning on or flickering:

- Check that the red Power Indicator LED on the Power Input side of the receiver is flashing. If it's not flashing the receiver isn't getting power, make sure the polarity of the power supply wires match the polarity of the channels on the Power Input Terminal.
- If the red Power Indicator LED on the Power Input side is flashing normally, check the polarity on the Power Output side. Make sure you have matched the markings on the LED strip to the channels on the receiver.
- Make sure all the connections (solderless connectors, solder joints, terminal blocks and spliced wires) are secure and making correct contact.
- Check that you have a compatible power supply, low voltage non-dimmable power supply that is big enough to handle the load of the LED strips you are using.

- If you are missing color temperatures or they don't match:

- Check the connections on the Power Output (LED side) of the receiver, the brown, yellow and white wires need to match the letters on each of the channels V+, B, G, R and W. Make sure the wires are properly stripped and contact in the screw terminals is done on the metal wire and not on the plastic insulation.
- If you have soldered the connection, make sure none of the solder points are touching each other, this will make the the channels that are touching work simultaneously.
- If you are using solderless connectors, apply pressure on the connector. If the issue is resolved with pressure change that connector. It could be faulty.
- Make sure you follow the letters indicating polarity on the LED strip throughout your setup when cutting the strip to avoid changing the color temperature from one section to another.

- If you can't sync the receiver with the remote:

- Revise the previous sync instructions to sync, assign zones and reset the receiver or remote.

WARRANTY

Limited Warranty on Purchased Items:

All products sold by Flexfire LEDs and shipped within the 50 United States, Canada, and Mexico come with a limited warranty. This limited warranty does not include product failures that are the result of:

1. Not using a voltage regulated driver to connect the LED product or controls;
2. Connecting LED products to the wrong Output Voltage;
3. Improper connection of drivers, LED products, or controls;
4. Connecting LED products or controls directly to any AC power source;
5. Connecting drivers backwards to an AC power source;
6. Using products in an extremely hot or cold environment and/or without adequate ventilation as overheating will cause the LEDs and transformers to fail more quickly;
7. Water damage to products not specifically sold as waterproof products;
8. Electrical power surges;
9. Damage from hail, flooding, tornado, fire, wind, earthquake, lightning, electrical storm, or any other natural disaster;
10. Damage caused by a vehicle or other accident;
11. Damage caused when transporting the item;
12. Damage to any products that were modified by the user, used for purposes other than as intended or directed, or connected to LED systems or components not purchased from Flexfire LEDs.

This limited warranty also expressly excludes coverage for excessive wear and tear and/or physical or accidental abuse, loss, or theft. Improper repair or warranty service performed by someone other than Flexfire LEDs will void this warranty. Buyer is responsible for the safe transport of any item sent to Flexfire LEDs for warranty service.

If you have an item you believe to be faulty, contact Flexfire LEDs immediately and request tech support. You may be required to provide photos, videos, and/or descriptions of the item(s) not performing properly. It is Flexfire LEDs goal to troubleshoot thoroughly to eliminate any unnecessary time or hassle on behalf of the customer. Failure to comply and provide the information requested by Flexfire LEDs will result in a void of warranty.

If a product is deemed faulty by a technician/representative, then a return shipping label and a Return Merchandise Authorization (RMA) form will be sent out immediately. Once Flexfire LEDs receives the product, we will test the item(s) to better understand where the fault in the product lie(s).

Flexfire LEDs will NOT provide replacement items before the original items have been returned, tested, and deemed faulty. If you need a replacement item while the return process is taking place, then you can repurchase that item. Once the testing process is complete and assuming the product is faulty, a refund will be issued for the purchase price of the product. Flexfire LEDs will not refund shipping costs on replacement items

If the product is found to be working properly and the error lies in the installation, or with other non-Flexfire LEDs products being used, then the product will be returned to the customer via our standard shipping method paid by the customer. If the customer has paid for a replacement item while the return process is being processed and the original product is found to be working properly, then the customer will receive the original product back and no refund.

Buyer's sole right under this warranty is for repair or replacement of the defective item.

This warranty is not transferable and applies only to the original purchaser of such items, provided that products purchased from an authorized Flexfire LEDs reseller will also include the above limited warranty. Proof of purchase may be required.

Warranty Period:

In the event of a product defect or malfunction, Flexfire LEDs will cover the cost of the return shipping. This is only valid during the product's warranty period stated by Flexfire LEDs. In this case a prepaid shipping label will be issued to the client via our standard shipping method.

- If the item is faulty, Flexfire LEDs will ship out a replacement at no charge.
- If the item is not faulty (still works), the client will need to pay for the shipping to get the product back to them.